



### ■ Features

- Constant Voltage + Constant Current mode output
- Metal housing design with functional Ground
- Built-in active PFC function
- Class 2 power unit
- No load / Standby power consumption <0.5W
- Suitable for use in Dry, Damp and Wet Locations
- Function options: output adjustable via potentiometer; 3 in 1 dimming (dim-to-off)
- Typical lifetime >50000 hours
- 5 years warranty

### ■ Applications

- LED street lighting
- LED architectural lighting
- LED bay lighting
- LED floodlighting
- Type "HL" for use in Class I, Division 2 hazardous (Classified) location.

### ■ GTIN CODE

MW Search: <https://www.meanwell.com/serviceGTIN.aspx>

### ■ Model Encoding

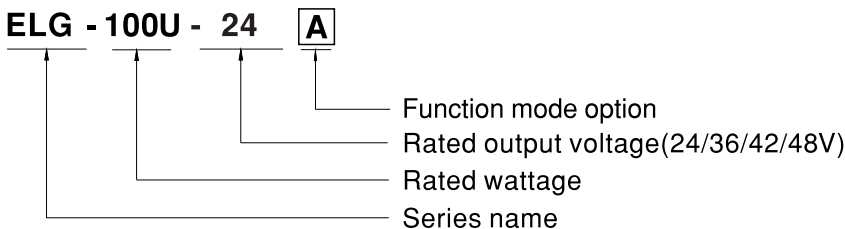

Type	Function	Note
Blank	Io and Vo fixed.	By Request
A	Io and Vo adjustable through built-in potentiometer.	By Request
B	3 in 1 dimming function (0~10Vdc, 10V PWM signal and resistance)	By Request



## SPECIFICATION

MODEL		ELG-100U-24□	ELG-100U-36□	ELG-100U-42□	ELG-100U-48□
OUTPUT	DC VOLTAGE	24V	36V	42V	48V
	CONSTANT CURRENT REGION <small>Note.2</small>	12 ~ 24V	18 ~ 36V	21 ~ 42V	24 ~ 48V
	RATED CURRENT	4.0A	2.66A	2.28A	2A
	RATED POWER	96W	95.76W	95.76W	96W
	RIPPLE & NOISE (max.) <small>Note.3</small>	200mVp-p	250mVp-p	250mVp-p	300mVp-p
	VOLTAGE ADJ. RANGE	Adjustable for A-Type only (via the built-in potentiometer)			
		21.6 ~ 26.4V	32.4 ~ 39.6V	37.8 ~ 46.2V	43.2 ~ 52.8V
	CURRENT ADJ. RANGE	Adjustable for A-Type only (via the built-in potentiometer)			
		2 ~ 4A	1.33 ~ 2.66A	1.14 ~ 2.28A	1 ~ 2A
	VOLTAGE TOLERANCE <small>Note.4</small>	±3.0%	±2.5%	±2.5%	±2.0%
	LINE REGULATION	±0.5%	±0.5%	±0.5%	±0.5%
LOAD REGULATION	±1.0%	±1.0%	±0.5%	±0.5%	
SETUP, RISE TIME <small>Note.6</small>	1000ms, 80ms/120VAC    500ms, 100ms/230VAC				
HOLD UP TIME (Typ.)	15ms/120VAC    10ms/230VAC				
INPUT	VOLTAGE RANGE <small>Note.5</small>	100 ~ 305VAC    142 ~ 431VDC (Please refer to "STATIC CHARACTERISTIC" section)			
	FREQUENCY RANGE	47 ~ 63Hz			
	POWER FACTOR	PF ≥ 0.97/120VAC, PF ≥ 0.95/230VAC, PF ≥ 0.92/277VAC@full load (Please refer to "POWER FACTOR (PF) CHARACTERISTIC" section)			
	TOTAL HARMONIC DISTORTION	THD < 20% (@load ≥ 50%/120VAC; @load ≥ 60%/230VAC; @load ≥ 75%/277VAC) (Please refer to TOTAL HARMONIC DISTORTION (THD) section)			
	EFFICIENCY (Typ.)	88%	89%	90%	90%
	AC CURRENT	1.1A / 120VAC	0.6A / 230VAC	0.5A / 277VAC	
	INRUSH CURRENT(Typ.)	COLD START 60A(twidth = 1.4ms measured at 10% Ipeak, twidth = 620us measured at 50% Ipeak) at 277VAC; Per NEMA 410			
	LEAKAGE CURRENT	<0.75mA / 277VAC			
PROTECTION	NO LOAD / STANDBY POWER CONSUMPTION	<0.5W			
	OVER CURRENT	95 ~ 108% Constant current limiting, recovers automatically after fault condition is removed			
	SHORT CIRCUIT	Hiccup mode, recovers automatically after fault condition is removed			
	OVER VOLTAGE	28 ~ 34V	41 ~ 48V	47 ~ 54V	54 ~ 62V
	OVER TEMPERATURE	Shut down output voltage with auto-recovery or re-power on to recover			
ENVIRONMENT	WORKING TEMP.	Tcase = -40 ~ +85°C (Please refer to "OUTPUT LOAD vs TEMPERATURE" section)			
	MAX. CASE TEMP.	Tcase = +85°C			
	WORKING HUMIDITY	20 ~ 95% RH non-condensing			
	STORAGE TEMP., HUMIDITY	-40 ~ +80°C, 10 ~ 95% RH			
	TEMP. COEFFICIENT	±0.03%/°C (0 ~ 60°C)			
SAFETY & EMC	VIBRATION	10 ~ 500Hz, 5G 12min./1cycle, period for 72min. each along X, Y, Z axes			
	SAFETY STANDARDS	UL8750 (type "HL"), CSA C22.22 No.250.13-12 approved			
	WITHSTAND VOLTAGE	I/P-O/P: 3.75KVAC    I/P-FG: 2.0KVAC    O/P-FG: 1.5KVAC			
	ISOLATION RESISTANCE	I/P-O/P, I/P-FG, O/P-FG: 100M Ohms / 500VDC / 25°C / 70% RH			
OTHERS	EMC EMISSION	Compliance to FCC part 15 class B			
	EMC IMMUNITY	Design refer to IEC61000-4-2, 3, 4, 5, 6, 8, 11; EN61547, light industry level			
	MTBF	2877.8K hrs min. Telcordia SR-332 (Bellcore)    287.5Khrs min. MIL-HDBK-217F (25°C)			
NOTE	DIMENSION	199*63*35.5mm (L*W*H)			
	PACKING	0.85kg; 16pcs/14.2kg/0.72CUFT			
<p>1. All parameters NOT specially mentioned are measured at 230VAC input, rated current and 25°C of ambient temperature.</p> <p>2. Please refer to "DRIVING METHODS OF LED MODULE". For DA-Type, Constant Current region is 60%~100% of maximum voltage under rated power delivery.</p> <p>3. Ripple &amp; noise are measured at 20MHz of bandwidth by using a 12" twisted pair-wire terminated with a 0.1uF &amp; 47uF parallel capacitor.</p> <p>4. Tolerance : includes set up tolerance, line regulation and load regulation.</p> <p>5. De-rating may be needed under low input voltages. Please refer to "STATIC CHARACTERISTIC" sections for details.</p> <p>6. Length of set up time is measured at first cold start. Turning ON/OFF the driver may lead to increase of the set up time.</p> <p>7. The driver is considered as a component that will be operated in combination with final equipment. Since EMC performance will be affected by the complete installation, the final equipment manufacturers must re-qualify EMC Directive on the complete installation again. (as available on <a href="https://www.meanwell.com/Upload/PDF/EML_statement_en.pdf">https://www.meanwell.com/Upload/PDF/EML_statement_en.pdf</a>)</p> <p>8. This series meets the typical life expectancy of &gt;50,000 hours of operation when Tcase, particularly (Tc) point (or TMP, per DLC), is about 80°C or less.</p> <p>9. Please refer to the warranty statement on MEAN WELL's website at <a href="http://www.meanwell.com">http://www.meanwell.com</a></p> <p>10. The ambient temperature derating of 3.5°C/1000m with fanless models and of 5°C/1000m with fan models for operating altitude higher than 2000m(6500ft).</p>					

### Block Diagram

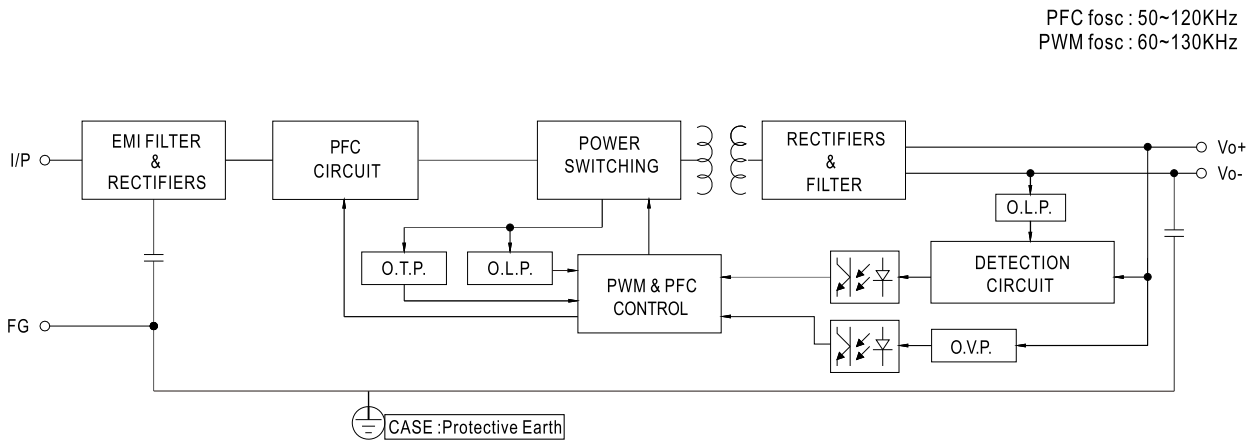

### DRIVING METHODS OF LED MODULE

※ This series is able to work in either Constant Current mode (a direct drive way) or Constant Voltage mode (usually through additional DC/DC driver) to drive the LEDs.

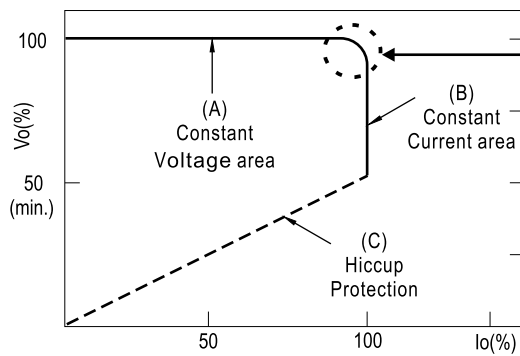

Typical output current normalized by rated current (%)

In the constant current region, the highest voltage at the output of the driver depends on the configuration of the end systems.

Should there be any compatibility issues, please contact MEAN WELL.

## ■ DIMMING OPERATION

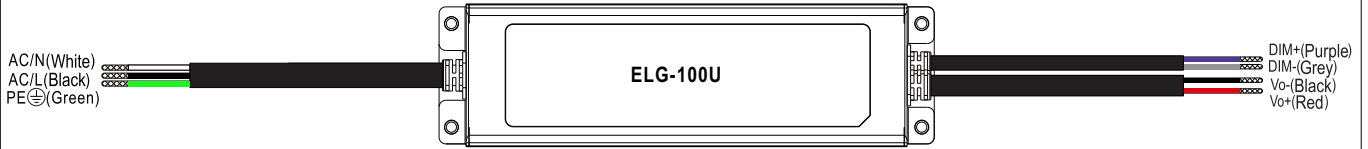

### ※ 3 in 1 dimming function (for B-Type)

- Output constant current level can be adjusted by applying one of the three methodologies between DIM+ and DIM-: 0 ~ 10VDC, or 10V PWM signal or resistance.
- Direct connecting to LEDs is suggested. It is not suitable to be used with additional drivers.
- Dimming source current from power supply: 100 $\mu$ A (typ.)

#### ◎ Applying additive 0 ~ 10VDC

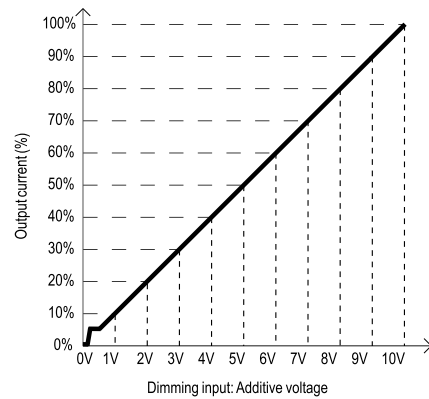
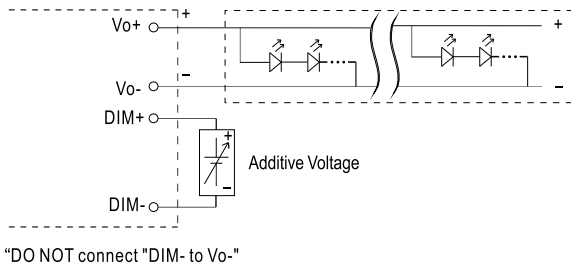

#### ◎ Applying additive 10V PWM signal (frequency range 100Hz ~ 3KHz):

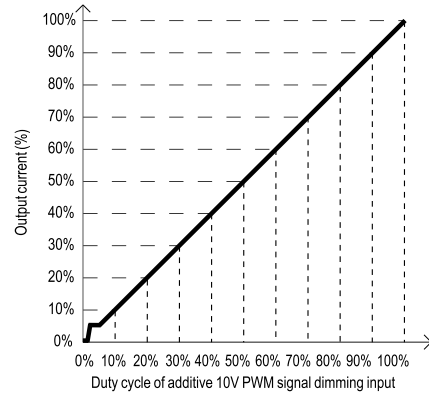
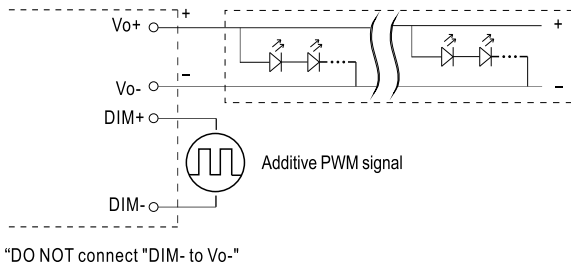

#### ◎ Applying additive resistance:

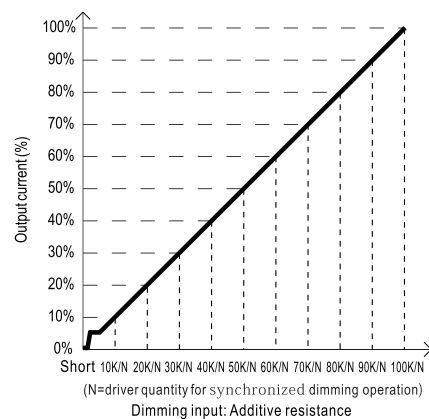
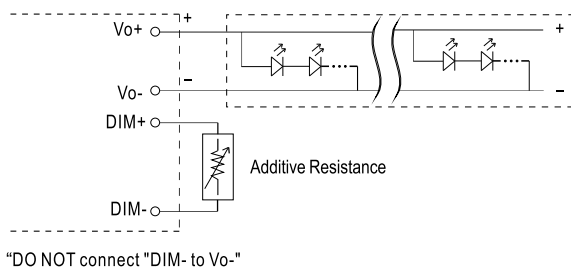

Note : 1. Min. dimming level is about 8% and the output current is not defined when 0% < I<sub>out</sub> < 8%.  
 2. The output current could drop down to 0% when dimming input is about 0k $\Omega$  or 0Vdc, or 10V PWM signal with 0% duty cycle.

### OUTPUT LOAD vs TEMPERATURE

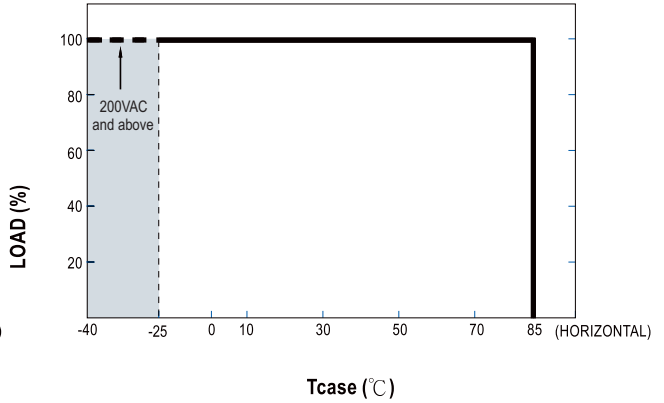
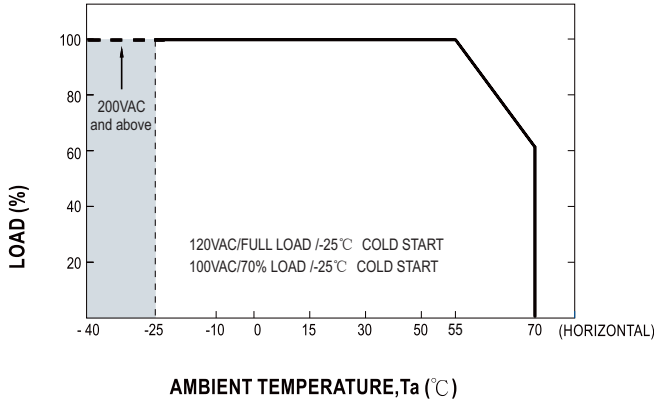

### STATIC CHARACTERISTIC

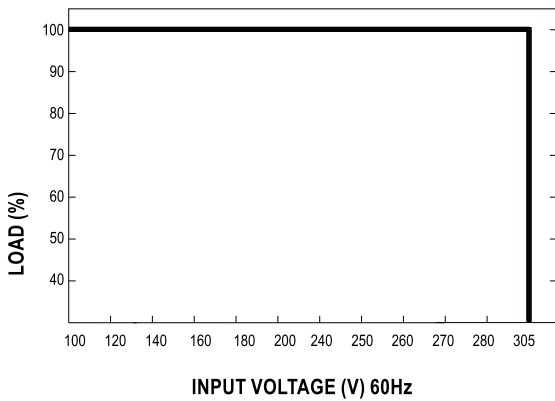

### POWER FACTOR (PF) CHARACTERISTIC

※ 48V Model, Tcase at 80°C

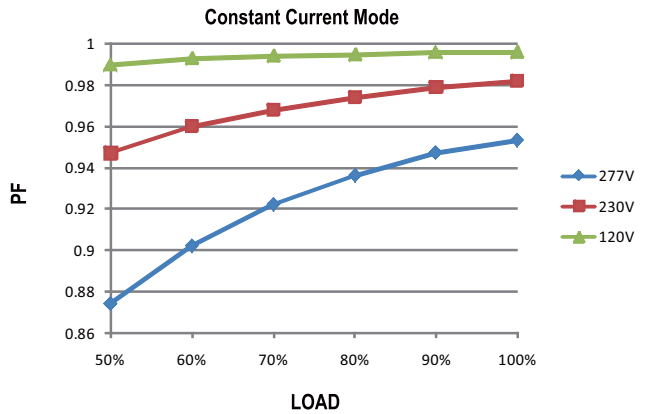

### TOTAL HARMONIC DISTORTION (THD)

※ 48V Model, Tcase at 80°C

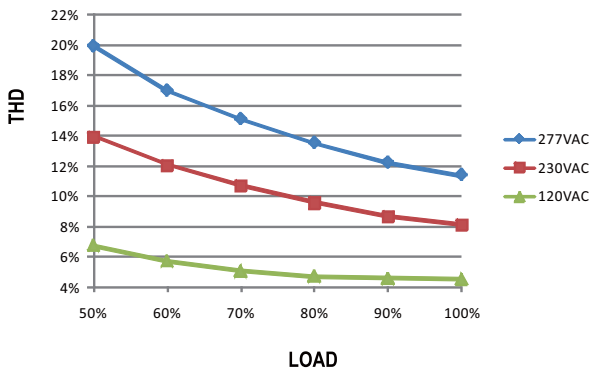

### EFFICIENCY vs LOAD

ELG-100U series possess superior working efficiency that up to 90% can be reached in field applications.

※ 48V Model, Tcase at 80°C

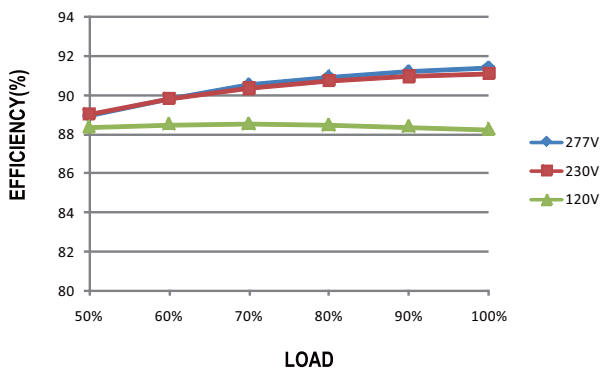



■ LIFE TIME

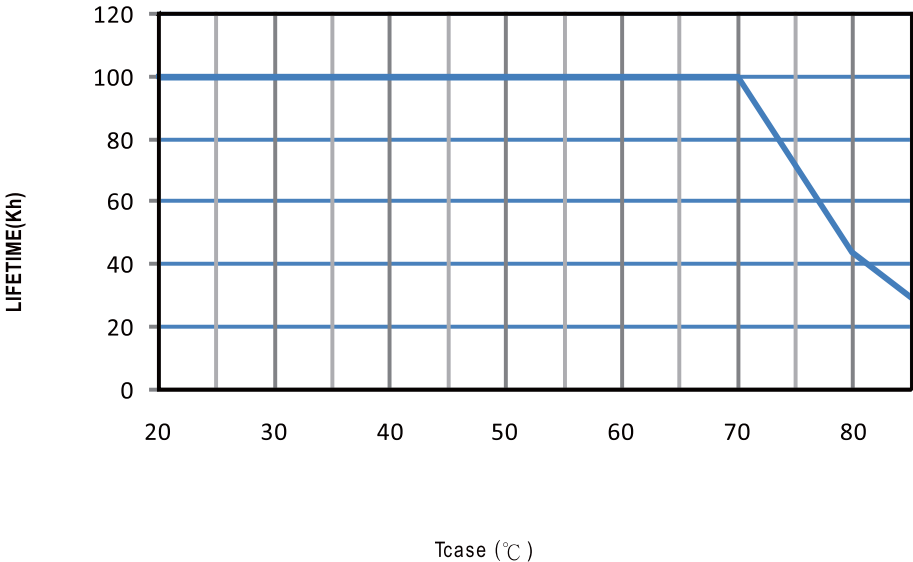

## ■ Mechanical Specification

※ Blank-Type

CASE NO.: 244A

Unit:mm

Tolerance:±1

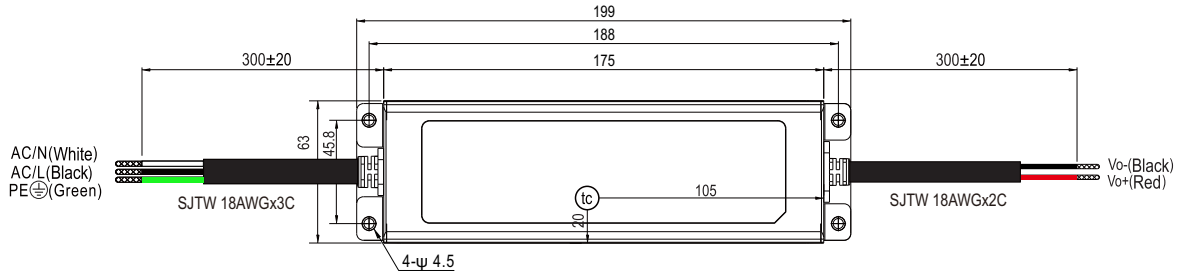

• (tc) : Max. Case Temperature



※ A-Type

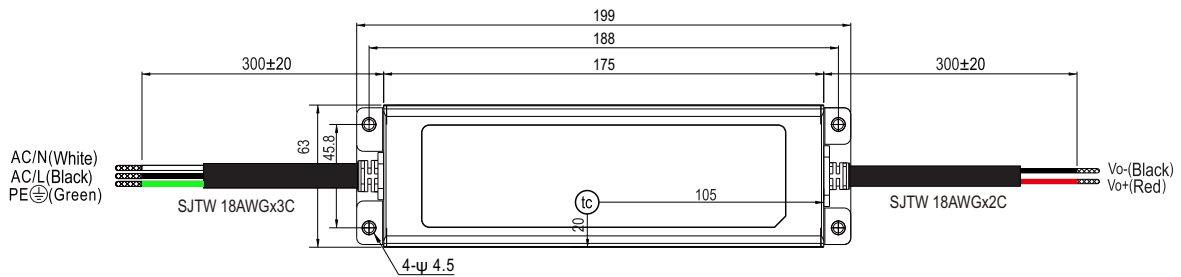

• (tc) : Max. Case Temperature

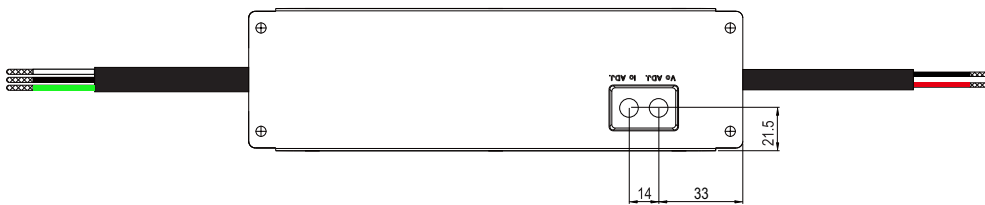

※ B-Type

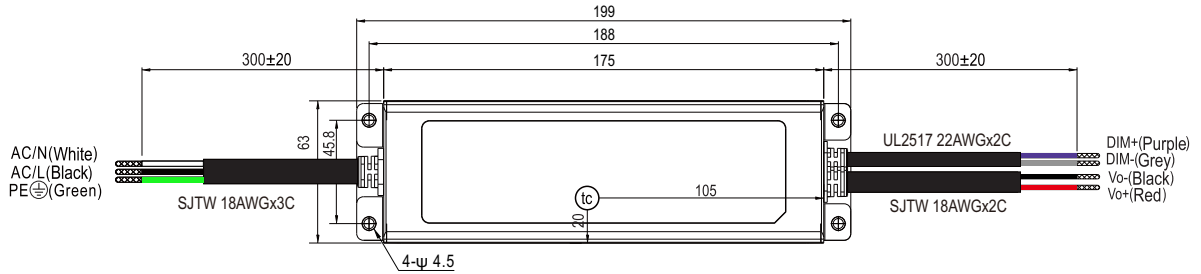

\* (tc) : Max. Case Temperature



■ Recommend Mounting Direction

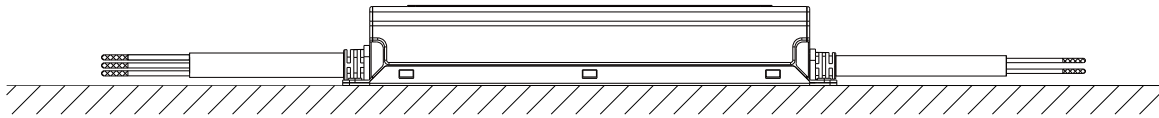

■ INSTALLATION MANUAL

Please refer to: <http://www.meanwell.com/manual.html>