

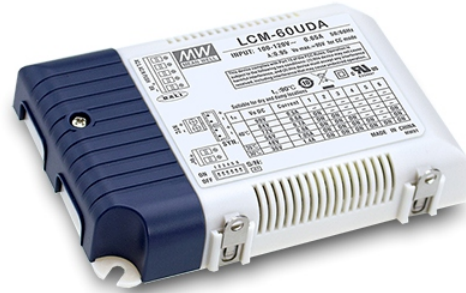

50W Multiple-Stage Constant Current Mode LED Driver **LCM-60UDA** series



■ Features

- Constant Current mode output with multiple levels selectable by dip switch
- Plastic housing with class II design
- Built-in active PFC function
- Functions: DALI interface(logarithm or linear dimming curve selectable), push dimming, synchronization up to 10units
- 3 years warranty

■ Applications

- LED indoor lighting
- LED office lighting
- LED architectural lighting
- LED panel lighting

■ GTIN CODE

MW Search: <https://www.meanwell.com/serviceGTIN.aspx>

■ Description

LCM-60UDA series is a 50W LED AC/DC constant current mode output LED driver featuring the multiple levels selectable by dip switch and the DALI interface with the compliance to IEC62386-207. LCM-60UDA operates from 90~132VAC and offers different current levels ranging between 350mA and 1050mA. Thanks to the efficiency up to 89%, with the fanless design, the entire series is able to operate for -30°C~+90°C case temperature under free air convection. In addition, LCM-60UDA is equipped with push dimming and synchronization so as to provide the optimal design flexibility for LED lighting system.

■ Model Encoding

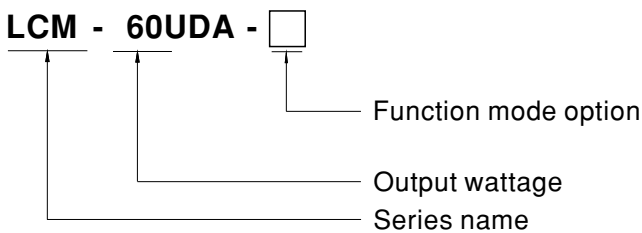

Type	Function	Note
Blank	DALI and push dimming	In Stock
AUX	DALI and push dimming and Auxiliary DC output	By request



50W Multiple-Stage Constant Current Mode LED Driver **LCM-60UDA** series

SPECIFICATION

MODEL		LCM-60UDA-□					
OUTPUT	CURRENT LEVEL	Current level selectable via DIP switch, please refer to "DIP SWITCH TABLE" section					
		500mA	600mA	700mA(default)	900mA	1050mA	1400mA
	RATED POWER	50.4W					
	DC VOLTAGE RANGE	2 ~ 90V	2 ~ 84V	2 ~ 72V	2 ~ 56V	2 ~ 48V	2 ~ 36V
	OPEN CIRCUIT VOLTAGE (max.)	102V			76V		
	CURRENT RIPPLE <small>Note.6</small>	5.0% max. @rated current					
	CURRENT TOLERANCE	±5%					
	AUXILIARY DC OUTPUT	Nominal 12V(deviation 11.4~12.6V)@50mA for AUX-Type only					
SETUP TIME <small>Note.3</small>	1000ms / 115VAC						
INPUT	VOLTAGE RANGE <small>Note.2</small>	90 ~ 132VAC 127 ~ 186VDC (Please refer to "STATIC CHARACTERISTIC" section)					
	FREQUENCY RANGE	47 ~ 63Hz					
	POWER FACTOR (Typ.)	PF ≥ 0.98/115VAC @full load (Please refer to "POWER FACTOR (PF) CHARACTERISTIC" section)					
	TOTAL HARMONIC DISTORTION	THD < 20% (@load ≥ 60%) (Please refer to "TOTAL HARMONIC DISTORTION(THD)" section)					
	EFFICIENCY (Typ.) <small>Note.4</small>	89%					
	AC CURRENT (Typ.)	0.65A/115VAC					
	INRUSH CURRENT (Typ.)	COLD START 15A(twidth=270µs measured at 50% Ipeak) at 115VAC; Per NEMA 410					
	MAX. No. of PSUs on 16A CIRCUIT BREAKER	15 units (circuit breaker of type B) / 25 units (circuit breaker of type C) at 115VAC					
LEAKAGE CURRENT	<0.5mA / 120VAC						
PROTECTION	SHORT CIRCUIT	Constant current limiting, recovers automatically after fault condition is removed					
	OVER VOLTAGE	105 ~ 125V					
		Shutdown o/p voltage, re-power on to recover					
OVER TEMPERATURE	Shutdown o/p voltage, re-power on to recover						
FUNCTION	DIMMING	Please refer to "DIMMING OPERATION" section					
	SYNCHRONIZATION	Please refer to "SYNCHRONIZATION OPERATION" section					
	TEMP. COMPENSATION	By external NTC, please refer to "TEMPERATURE COMPENSATION OPERATION" section					
ENVIRONMENT	WORKING TEMP.	Tcase = -30 ~ +90°C (Please refer to "OUTPUT LOAD vs TEMPERATURE" section)					
	MAX. CASE TEMP.	Tcase = +90°C					
	WORKING HUMIDITY	20 ~ 90% RH non-condensing					
	STORAGE TEMP., HUMIDITY	-40 ~ +80°C, 10 ~ 95% RH					
	TEMP. COEFFICIENT	±0.03%/°C (0 ~ 50°C)					
	VIBRATION	10 ~ 500Hz, 2G 10min./1cycle, period for 60min. each along X, Y, Z axes					
SAFETY & EMC	SAFETY STANDARDS	UL8750 approved					
	DALI STANDARDS	Comply with IEC62386-101, 102, 207					
	WITHSTAND VOLTAGE	I/P-O/P: 3.75KVAC					
	ISOLATION RESISTANCE	I/P-O/P: >100M Ohms / 500VDC / 25°C / 70% RH					
	EMC EMISSION	Compliance to FCC part 15 Subpart B					
OTHERS	MTBF	2284.6K hrs min. Telcordia SR-332 (Bellcore) ; 222.5K hrs min. MIL-HDBK-217F (25°C)					
	DIMENSION	123.5*81.5*23mm (L*W*H)					
	PACKING	0.28Kg ; 54pcs/16Kg/1.12CUFT					
NOTE	<ol style="list-style-type: none"> All parameters NOT specially mentioned are measured at 115VAC input, rated current and 25°C of ambient temperature. De-rating may be needed under low input voltages. Please refer to "STATIC CHARACTERISTIC" sections for details. Length of set up time is measured at first cold start. Turning ON/OFF the driver may lead to increase of the set up time. Efficiency is measured at 700mA/72V output set by DIP switch. The driver is considered as a component that will be operated in combination with final equipment. Since EMC performance will be affected by the complete installation, the final equipment manufacturers must re-qualify EMC Directive on the complete installation again. (as available on https://www.meanwell.com/Upload/PDF/EMI_statement_en.pdf) It is measured 60%~100% of maximum voltage under rated power delivery. The ambient temperature derating of 3.5°C/1000m with fanless models and of 5°C/1000m with fan models for operating altitude higher than 2000m(6500ft). <p>※ Product Liability Disclaimer : For detailed information, please refer to https://www.meanwell.com/serviceDisclaimer.aspx</p>						

■ BLOCK DIAGRAM

PFC fosc : 60KHz
PWM fosc : 80KHz

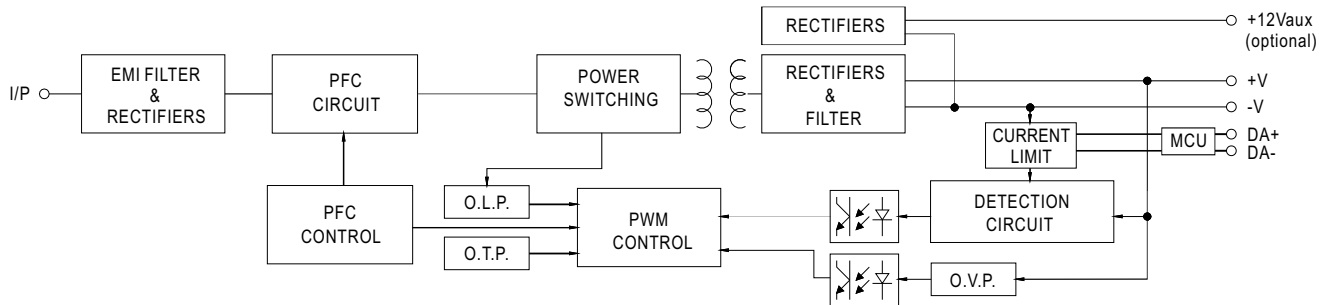

■ DIP SWITCH TABLE

LCM-60UDA is a multiple-stage constant current driver, selection of output current through DIP switch is exhibited below.

Io \ DIP S.W.	1	2	3	4	5	6
500mA	----	----	----	----	----	----
600mA	ON	----	----	----	----	----
700mA(factory default)	ON	ON	----	----	----	----
900mA	ON	ON	ON	----	----	ON
1050mA	ON	ON	ON	ON	----	ON
1400mA	ON	ON	ON	ON	ON	ON

■ DIMMING OPERATION

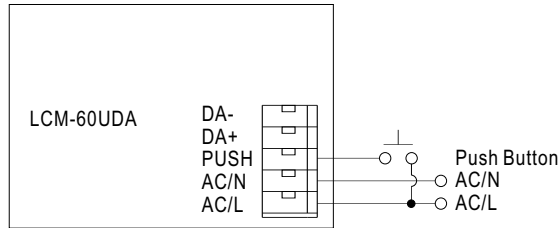

※PUSH dimming(primary side)

Action	Action duration	Function
Short push	0.1~1 sec.	Turn ON-OFF the driver
Long push	1.5~10 sec.	Every Long Push changes the dimming direction, dimming up or down
Reset	>11 sec.	Set up the dimming level to 100%

- The factory default dimming level is at 100%.
- If the push action lasts less than 0.05 sec., it will not lead to a change for the status of the driver.
- Up to 10 drivers can perform the PUSH dimming at the same time when utilizing one common push button.
- The maximum length of the cable from the push button to the last driver is 20 meters.
- The additive push button can be connected only between the PUSH terminal, as displayed in the diagram, and AC/L (in brown or black); it will lead to short circuit if it is connected to AC/N.

※DALI interface(primary side)

- Apply DALI signal between DA+ and DA-
- DALI protocol comprises 16 groups and 64 addresses.
- First step is fixed at 6% of output.

■ SYNCHRONIZATION OPERATION

- Synchronization up to 10 drivers (1 master + 9 slaves)
- Dimming operating range : 10%~100%
- Sync cable length : < 5m
- Sync cable type : Flat cable
- Sync cable cross section area : 22 – 24 AWG (0.2~0.3mm²)

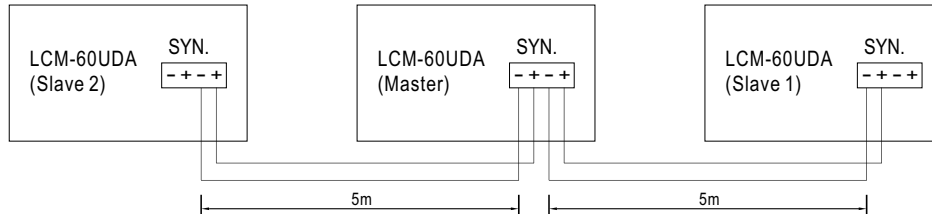

NOTE: 1. Please make sure all units are set to 100% dimming setting (factory default) before synchronizing.
2. Min. Dimming operating range depends on dimmer setting.

■ TEMPERATURE COMPENSATION OPERATION

LCM-60UDA have the built-in temperature compensation function ; by connecting a temperature sensor (NTC resistor) between the +NTC/-NTC terminal of LCM-60UDA and the detecting point on the lighting system or the surrounding environment, output current of LCM-60UDA could be correspondingly changed, based on the sensed temperature, to ensure the long life of LED.

NTC derating curve

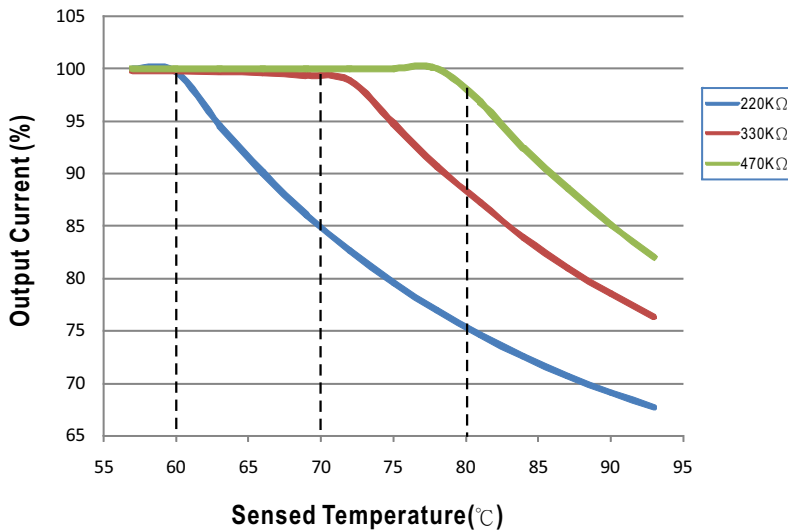

⊙ LCM-60UDA can still be operated normally when the NTC resistor is not connected and the value of output current will be the current level selected through the DIP switch.

⊙ NTC reference:

NTC resistance	Output Current
220K	< 60°C, 100% of the rated current (corresponds to the setting current level) > 60°C, output current begins to reduce, please refer to the curve for details.
330K	< 70°C, 100% of the rated current (corresponds to the setting current level) > 70°C, output current begins to reduce, please refer to the curve for details.
470K	< 80°C, 100% of the rated current (corresponds to the setting current level) > 80°C, output current begins to reduce, please refer to the curve for details.

Notes: 1. MEAN WELL does not offer the NTC resistor and all the data above are measured by using THINKING TTC03 series.

2. If other brands of NTC resistor is applied, please check the temperature curve first.

⊙ Dimming and synchronization function of the driver will be invalid when the "temperature compensation" function is in use.

OUTPUT LOAD vs TEMPERATURE

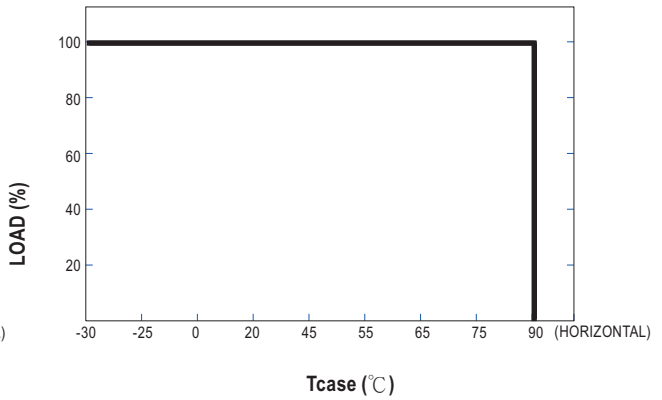
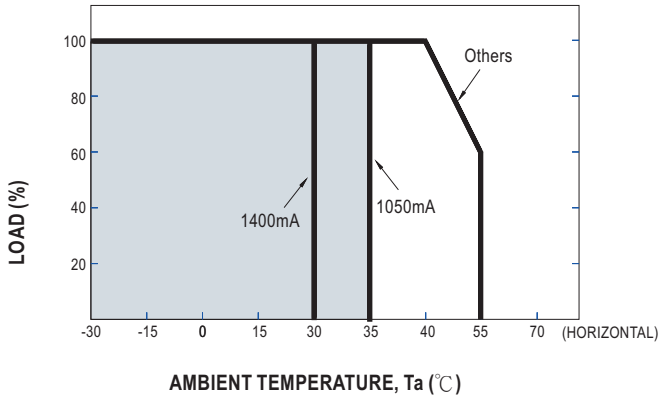

STATIC CHARACTERISTIC

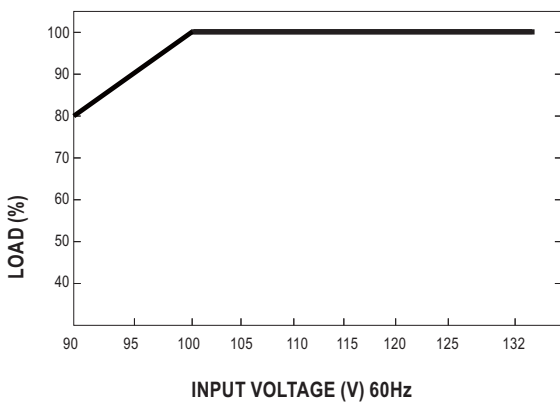

※ De-rating is needed under low input voltage.

POWER FACTOR (PF) CHARACTERISTIC

※ Tcase at 80°C

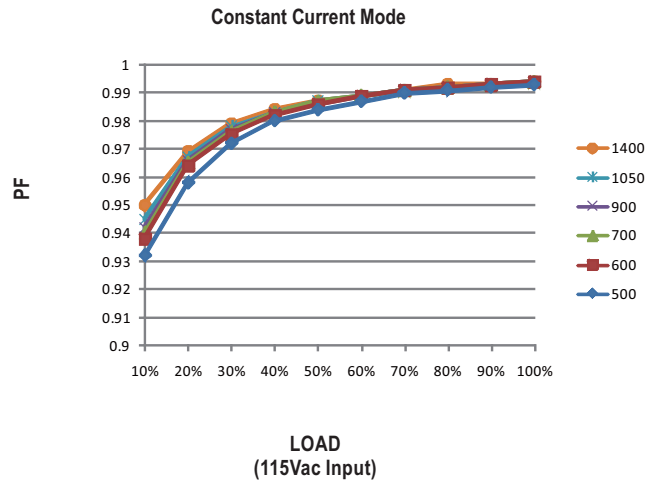

TOTAL HARMONIC DISTORTION (THD)

※ Tcase at 80°C

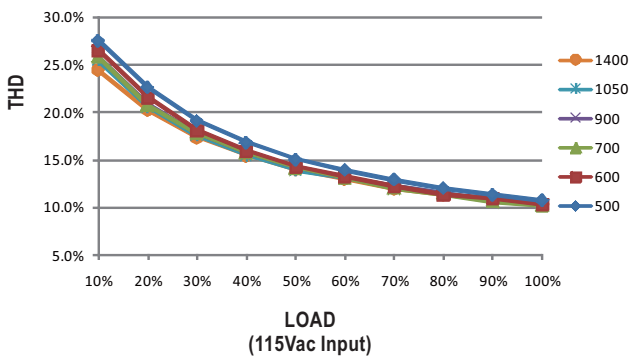

EFFICIENCY vs LOAD

LCM-60UDA series possess superior working efficiency that up to 89% can be reached in field applications.

※ Tcase at 80°C

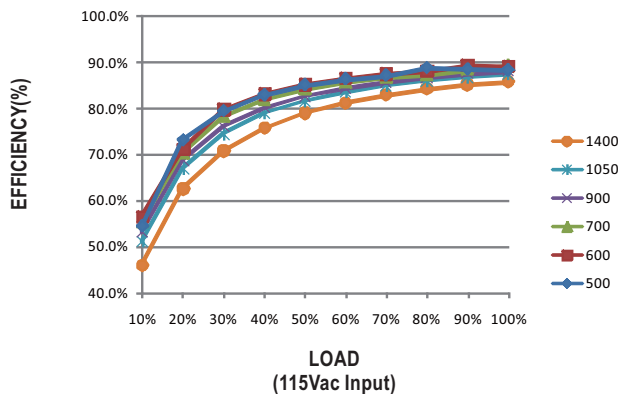

MECHANICAL SPECIFICATION

Case No. LCM-60A Unit: mm Tolerance: ±1

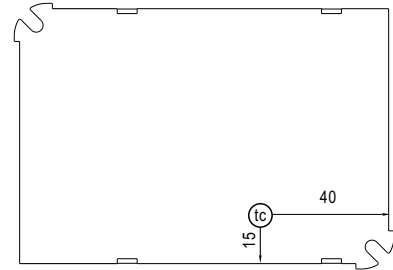
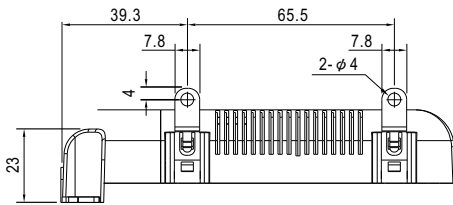
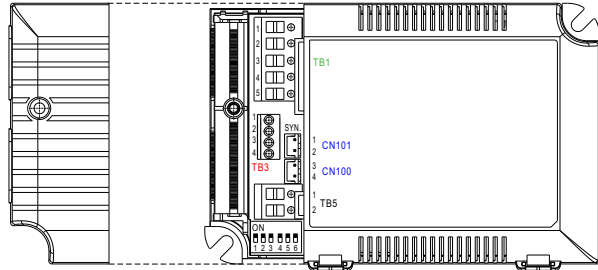
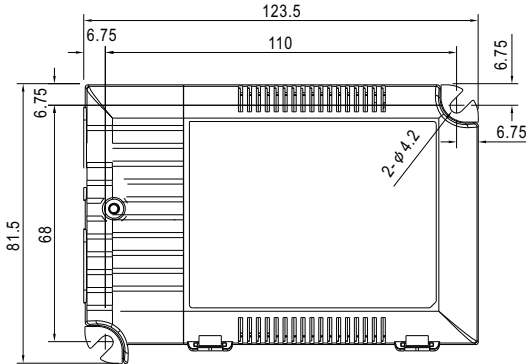

Bottom View

• (tc) : Max. Case Temperature

※ Terminal Pin No. Assignment(TB1)

Pin No.	Assignment	Pin No.	Assignment
1	AC/L	4	DA+
2	AC/N	5	DA-
3	PUSH		

※ Terminal Pin No. Assignment(TB3)

Pin No.	Assignment	Pin No.	Assignment
1	+FAN(optional)	3	+NTC
2	-FAN(optional)	4	-NTC

◎ Pin1(+FAN) / Pin2(-FAN) is the Auxiliary DC output for the optional model LCM-60UDA-AUX; it can be used to drive fan.

※ Terminal Pin No. Assignment(TB5)

Pin No.	Assignment
1	+V
2	-V

※ SYN. Connector(CN101/CN100):JST B2B-XH or equivalent

Pin No.	Assignment	Mating Housing	Terminal
1,3	+	JST XHP or equivalent	JST SXH-001T-P0.6 or equivalent
2,4	-		