



Features

- Bluetooth wireless LED driver
- Constant voltage PWM style output with frequency up to 4kHz design compliant IEEE1789-2015
- Plastic housing with class II design
- Built-in active PFC function
- Fully encapsulated with IP67 level(except SVA and BLE type)
- Typical lifetime >50000 hrs and 5 years warranty

Applications

- LED strip lighting
- Indoor LED lighting
- LED decorative lighting
- LED architecture lighting
- Cove lighting
- Type “HL” for use in class I, division 2 hazardous (classified) location.

GTIN CODE

MW Search: <https://www.meanwell.com/serviceGTIN.aspx>

Description

PWM-200 IoT series is a 200W AC/DC LED driver featuring the constant voltage mode with PWM style output, which is able to maintain the color temperature and the brightness homogeneity when driving all kinds of LED strips. PWM-200IoT operates from 100~305VAC and offers models with different rated voltage ranging between 12V and 48V. Thanks to the high efficiency up to 94%, with the fanless design, the entire series is able to operate for -20°C~+85°C case temperature under free air convection. The entire series is rated with IP67 ingress protection level and suitable to work for dry, damp or wet locations. PWM-200 IoT can provide dimming level low to 0.4% suitable for low light level applications e.g. cinema. The output frequency is up to 4kHz which compliant to IEEE1789-2015 requirement for no risk providing a great solution for health concern due to light flickering.

Model Encoding

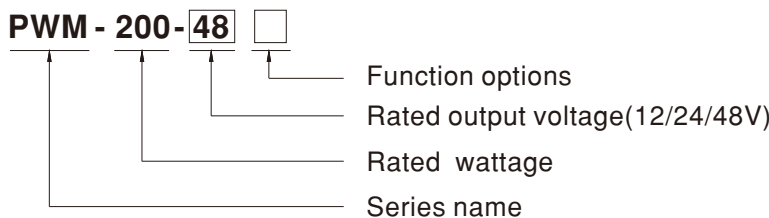

IoT wireless lighting brand and solution

Type	Solution	Wireless standard	Note
BLE	Casambi	Bluetooth Mesh low energy 2.4GHz protocol	By request
TY1	Tuya	Bluetooth Mesh low energy 2.4GHz protocol	By request
SVA	Silvair	Bluetooth Mesh low energy 2.4GHz protocol	By request
WZ1	WiZ	Bluetooth Mesh low energy+Wifi 2.4GHz protocol	By request

SPECIFICATION

MODEL		PWM-200-12 <input type="checkbox"/>	PWM-200-24 <input type="checkbox"/>	PWM-200-48 <input type="checkbox"/>	
OUTPUT	DC VOLTAGE	12V	24V	48V	
	RATED CURRENT	15A	8.3A	4.17A	
	RATED POWER	180W	199.2W	200.2W	
	DIMMING RANGE	0 ~ 100%			
	PWM FREQUENCY (Typ.)	4kHz for BLE, 2.5kHz for TY1, 1kHz for SVA, 200Hz for WZ1			
	SETUP, RISE TIME Note.2	1000ms, 80ms/115VAC or 230VAC for BLE, WZ1 and TY1; 2000ms, 80ms/115VAC or 230VAC for SVA			
	HOLD UP TIME (Typ.)	10ms/230VAC or 115VAC			
INPUT	VOLTAGE RANGE Note.3	100 ~ 305VAC 142 ~ 431VDC (Please refer to "STATIC CHARACTERISTIC" section)			
	FREQUENCY RANGE	47 ~ 63Hz			
	POWER FACTOR (Typ.)	PF>0.97/115VAC, PF>0.96/230VAC, PF>0.94/277VAC @ full load (Please refer to "POWER FACTOR (PF) CHARACTERISTIC" section)			
	TOTAL HARMONIC DISTORTION	THD<20% (@load≥60%/115VAC, 230VAC; @load≥75%/277VAC) (Please refer to "TOTAL HARMONIC DISTORTION" section)			
	EFFICIENCY (Typ.)	WZ1 Type	91.5%	92.5%	93.5%
		Other Type	92%	93%	94%
	AC CURRENT (Typ.)	2.2A / 115VAC	1.1A / 230VAC	0.9A / 277VAC	
	INRUSH CURRENT (Typ.)	COLD START 65A(twidth=550μs measured at 50% Ipeak) at 230VAC; Per NEMA 410			
	MAX. NO. of PSUs on 16A CIRCUIT BREAKER	3 units (circuit breaker of type B) / 6 units (circuit breaker of type C) at 230VAC			
	LEAKAGE CURRENT	<0.75mA / 277VAC			
STANDBY POWER CONSUMPTION	Standby power consumption<2.5W when dimming off				
PROTECTION	OVERLOAD	108 ~ 135% rated output power Hiccup mode or Constant current limiting, recovers automatically after fault condition is removed			
	SHORT CIRCUIT	Shut down o/p voltage, re-power on to recover			
	OVER VOLTAGE	13 ~ 18V	27 ~ 34V	53 ~ 65V	
		Shut down o/p voltage, re-power on to recover after fault condition is removed			
	OVER TEMPERATURE	Shut down o/p voltage, re-power on to recover after fault condition is removed			
ENVIRONMENT	WORKING TEMP.	Tcase=-20 ~ +85°C (Please refer to " OUTPUT LOAD vs TEMPERATURE" section)			
	MAX. CASE TEMP.	Tcase=+85°C			
	WORKING HUMIDITY	20 ~ 95% RH non-condensing			
	STORAGE TEMP., HUMIDITY	-20 ~ +80°C, 10 ~ 95% RH			
	TEMP. COEFFICIENT	±0.03%/°C (0 ~ 50°C)			
	VIBRATION	10 ~ 500Hz, 5G 12min./1cycle, period for 72min. each along X, Y, Z axes			
FUNCTION	WIERLESS PROTOCOL	Bluetooth low energy 2.4GHz protocol			
	WIERLESS DISTANCE	Up to 20m			
	DIMMING Note.10	Please refer to "DIMMING OPERATION" section			
SAFETY & EMC	SAFETY STANDARDS Note.5	UL8750(type "HL"), CSA C22.2 No. 250.13-12; ENEC BS EN/EN61347-1, BS EN/EN61347-2-13, BS EN/EN62384 independent, IP67(except SVA and BLE type), EAC TP TC 004, GB19510.1,GB19510.14 approved; Design refer to BS EN/EN60335-1, BIS			
	WITHSTAND VOLTAGE	I/P-O/P: 3.75KVAC			
	ISOLATION RESISTANCE	I/P-O/P: 100M Ohms / 500VDC / 25 °C / 70% RH			
	EMC EMISSION Note.6	Compliance to BS EN/EN55015, BS EN/EN61000-3-2 Class C (@load≥60%) ; BS EN/EN61000-3-3, GB/T 17743, GB17625.1.,EAC TP TC 020			
	EMC IMMUNITY	Compliance to BS EN/EN61000-4-2,3,4,5,6,8,11; BS EN/EN61547, light industry level (surge immunity, Line-Line 2KV),EAC TP TC 020			
OTHERS	MTBF	2413.4 K hrs min. Telcordia SR-332 (Bellcore) ; 211.1 K hrs min. MIL-HDBK-217F (25°C)			
	DIMENSION	195*68*39.5mm (L*W*H)			
	PACKING	1.03Kg; 12pcs/13.4Kg/0.71CUFT			

NOTE

- All parameters NOT specially mentioned are measured at 230VAC input, rated current and 25°C of ambient temperature.
- Length of set up time is measured at first cold start. Turning ON/OFF the driver may lead to increase of the set up time.
- De-rating may be needed under low input voltages. Please refer to "STATIC CHARACTERISTIC" sections for details.
- The driver is considered as a component that will be operated in combination with final equipment. Since EMC performance will be affected by the complete installation, the final equipment manufacturers must re-qualify EMC Directive on the complete installation again.
(as available on https://www.meanwell.com/Upload/PDF/EML_statement_en.pdf)
- This series meets the typical life expectancy of >50,000 hours of operation when Tcase, particularly (C) point (or TMP, per DLC), is about 75°C or less.
- Please refer to the warranty statement on MEAN WELL's website at <http://www.meanwell.com>
- The ambient temperature derating of 3.5°C/1000m with fanless models and of 5°C/1000m with fan models for operating altitude higher than 2000m(6500ft).
- For any application note and IP water proof function installation caution, please refer our user manual before using.
https://www.meanwell.com/Upload/PDF/LED_EN.pdf
- It is not recommended to connect to capacitive loads.
- The dimming memory function of TY1 type needs at least 5 seconds to complete.
- The matching mode of TY1 type is on-off-on-off-on by AC or DC power.
- To fulfill requirements of the latest ErP regulation for lighting fixtures, this LED power supply can only be used behind a switch without permanently connected to the mains.

× Product Liability Disclaimer : For detailed information, please refer to <https://www.meanwell.com/serviceDisclaimer.aspx>

■ DIMMING OPERATION

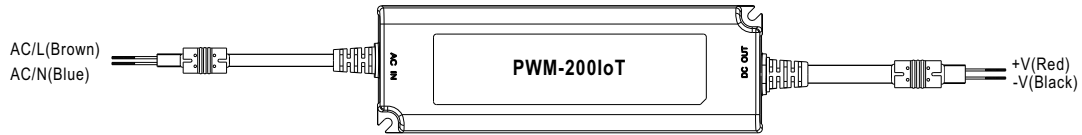

※ **Dimming principle for PWM style output**

• Dimming is achieved by varying the duty cycle of the output current.

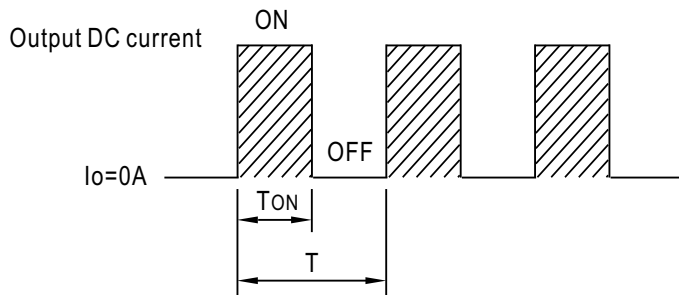

$$\text{Duty cycle(\%)} = \frac{T_{ON}}{T} \times 100\%$$

Output PWM frequency : up to 4KHz

※ **Bluetooth control**

- To be used through APP available on Apple Store and Google Play Store for iOS and Android.
Search: BLE with Casambi/TY1 with Smart Life/SVA with Silvrair/WZ1 with WiZ
Example:



The APP for BLE type is "Casambi"

The APP for TY1 type is "Smart Life"

The APP for SVA type is "Silvrair"

The APP for WZ1 type is "WiZ CN"

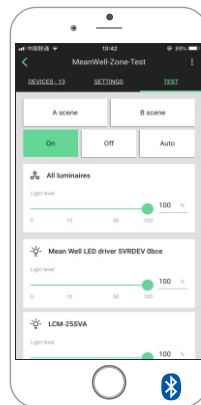
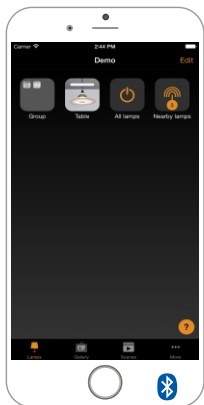

OFFICIAL WEBSITE AND ECOSYSTEM INFORMATION

CASAMBI

The real time Bluetooth IC temperature is shown in the APP. In case it reaches above 65 °C (equivalent to Tc 80°C), the driver will be turn off to provide a protection. In case the units is cooled down, it can be manually turn ON and back to normal operation again.

NOTE: 1.This software temperature protection is an extra independent function from driver its own hardware over temperature protection(when it is enabled, it needs re-AC power on to recover).

2.In general the software temperature protection is triggered before the hardware one when in over temperature.

3.Website: <https://www.casambi.com>



Adding new device:

1. Install the app on the mobile device.Please go to the App Store for iOS or Google Play for Android, and search for "Smart Life" to download.



2. Turn on the phone's Bluetooth and open the "Smart Life" app.
3. Register an account. Register an account to be able to use the dedicated application.
If you have already registered an account, please enter your country/region, account and password to login.

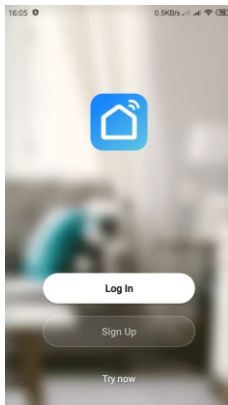

4. Click "Add Device" and select "Light Source(BLE)" from the lighting type.

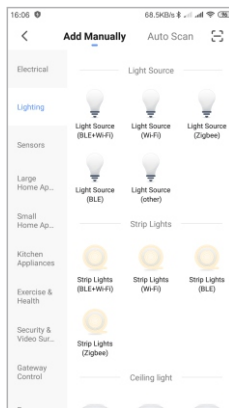
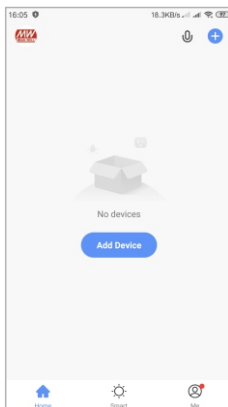

5. Reset the device. Please follow the 3 steps in the diagram to complete the setup.

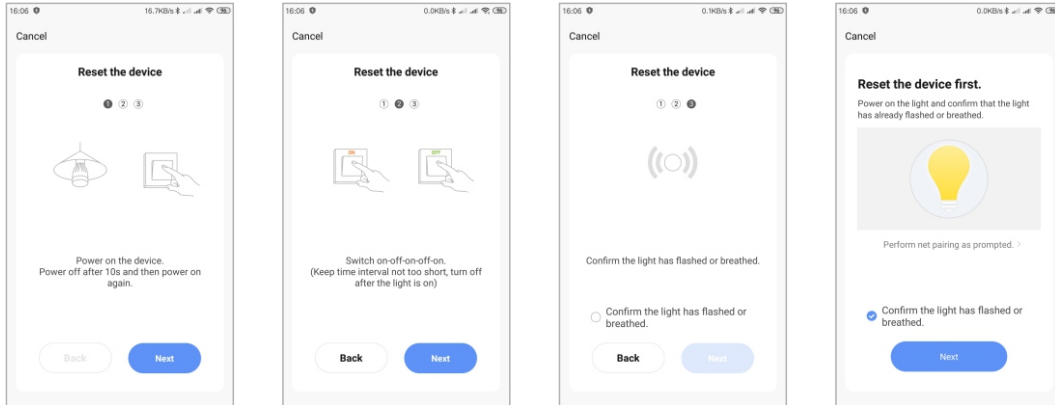

6. Wait for the system to search for the device and connect it. When the steps are finished, click "Done" to connect successfully.

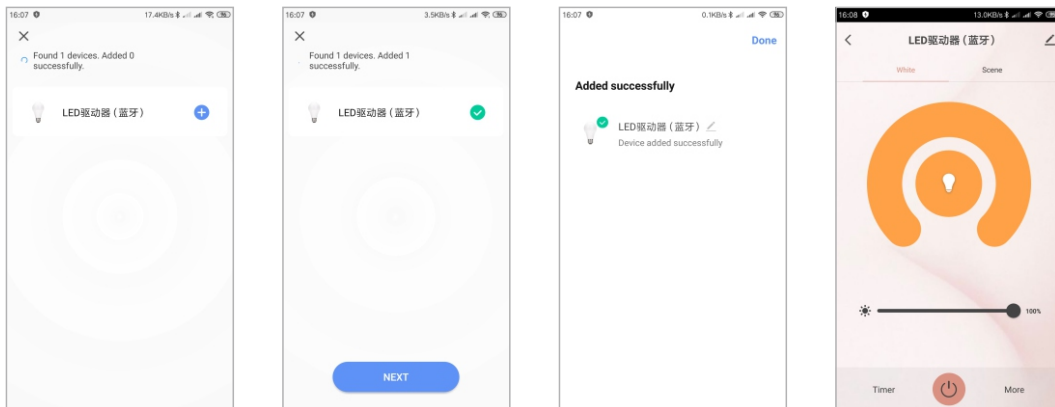

NOTE: 1.Website: <https://www.tuya.com>

SILVAIR

NOTE: 1.Website: <https://www.silvair.com>

WiZ
CONNECTED

NOTE: 1.Website:<https://www.wizconnected.com>

OUTPUT LOAD vs TEMPERATURE

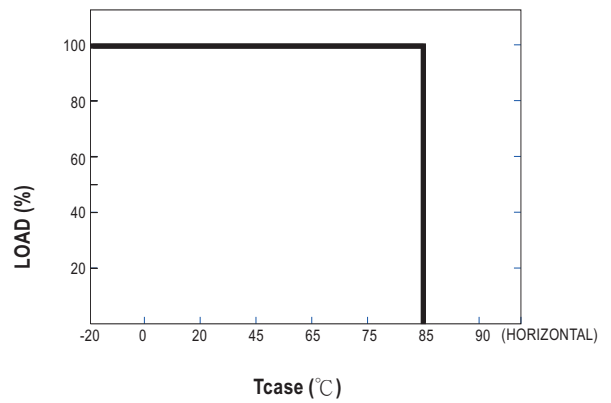
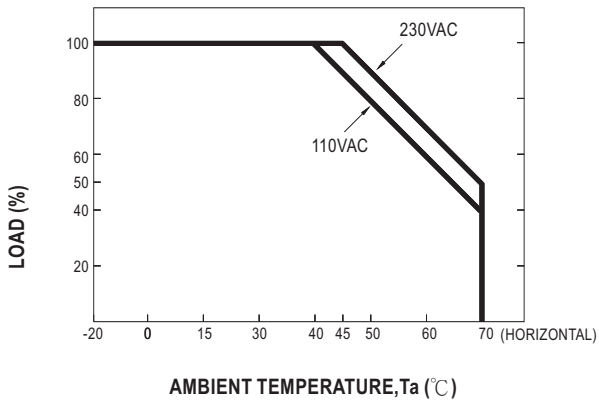

STATIC CHARACTERISTIC

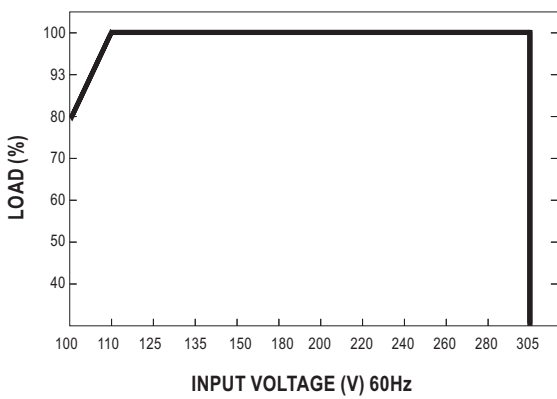

POWER FACTOR (PF) CHARACTERISTIC

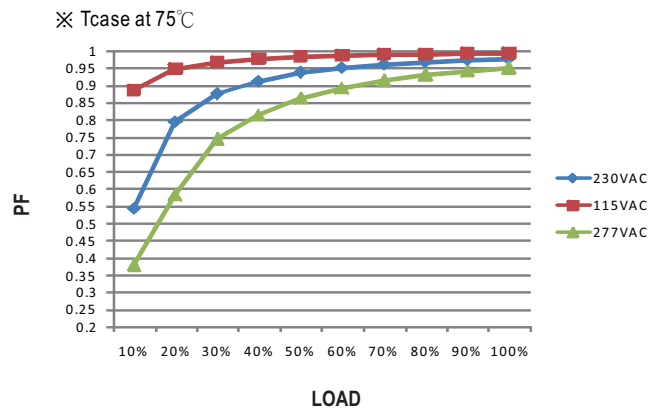

TOTAL HARMONIC DISTORTION (THD)

※ 48V Model, Tcase at 75°C

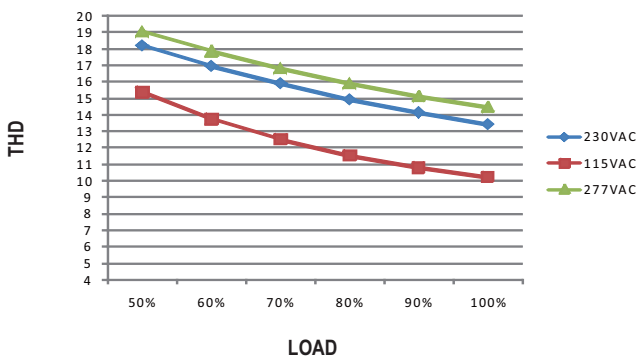

EFFICIENCY vs LOAD

PWM-200 series possess superior working efficiency that up to 94% can be reached in field applications.

※ 48V Model, Tcase at 75°C

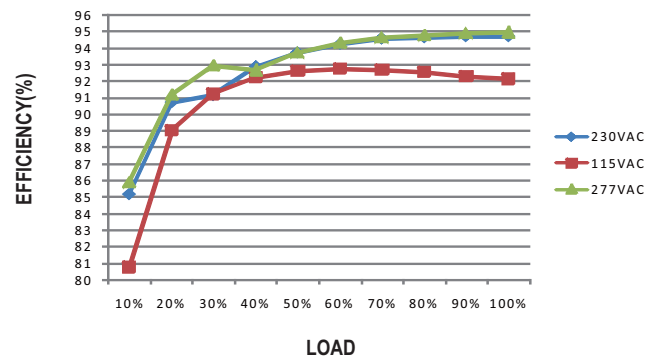

■ LIFE TIME

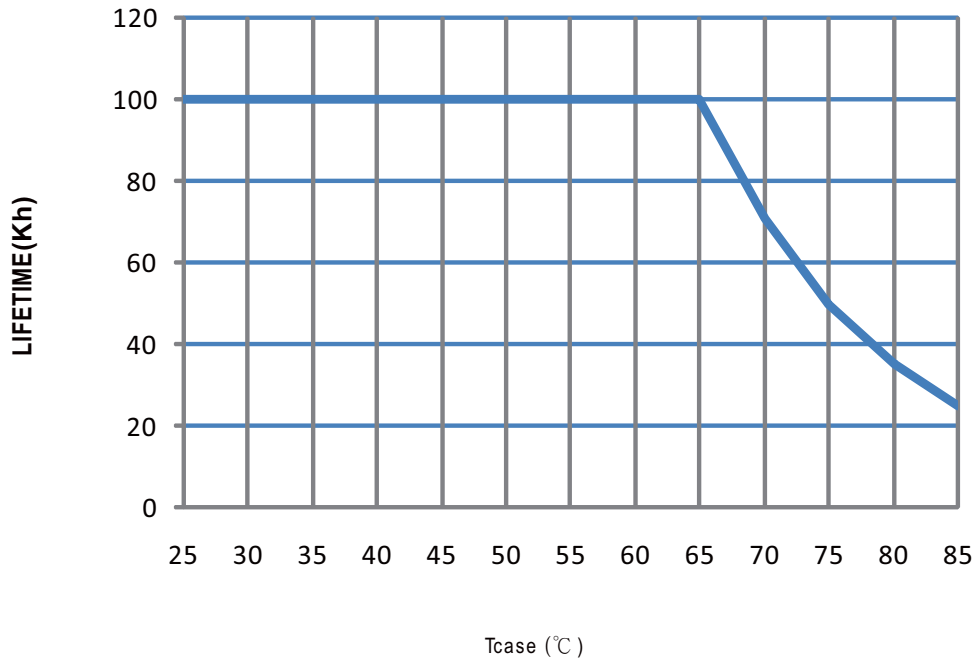

■ Bluetooth mesh LED driver for intelligent lighting Application

PWM-60/90/120/200 Series

Multi-Dimming Function LED Driver and Wireless IoT Solutions

- 0-10V
- PWM
- Resistance
- Push Dimming
- DALI / DALI 2.0
- KNX
- Bluetooth Mesh
- WiFi.....and so on



■ **Block Diagram**

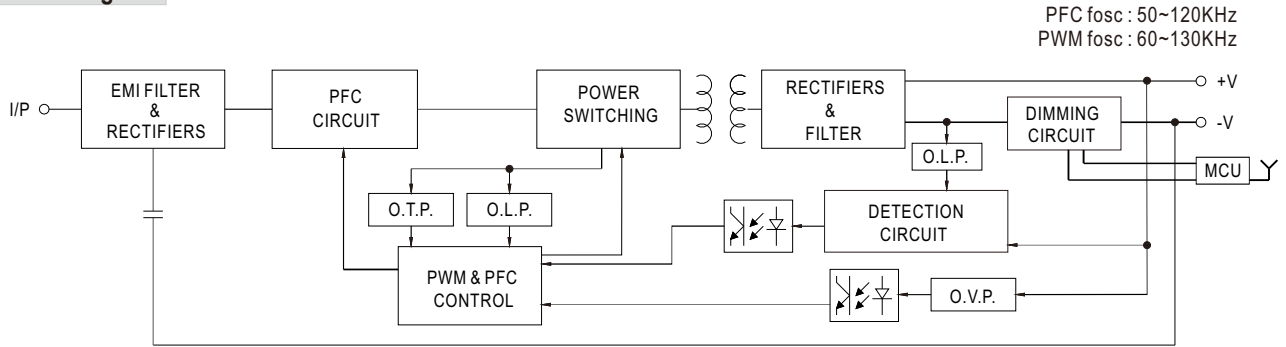

■ **Mechanical Specification**

Case No. PWM-200 Unit:mm Tolerance:±1

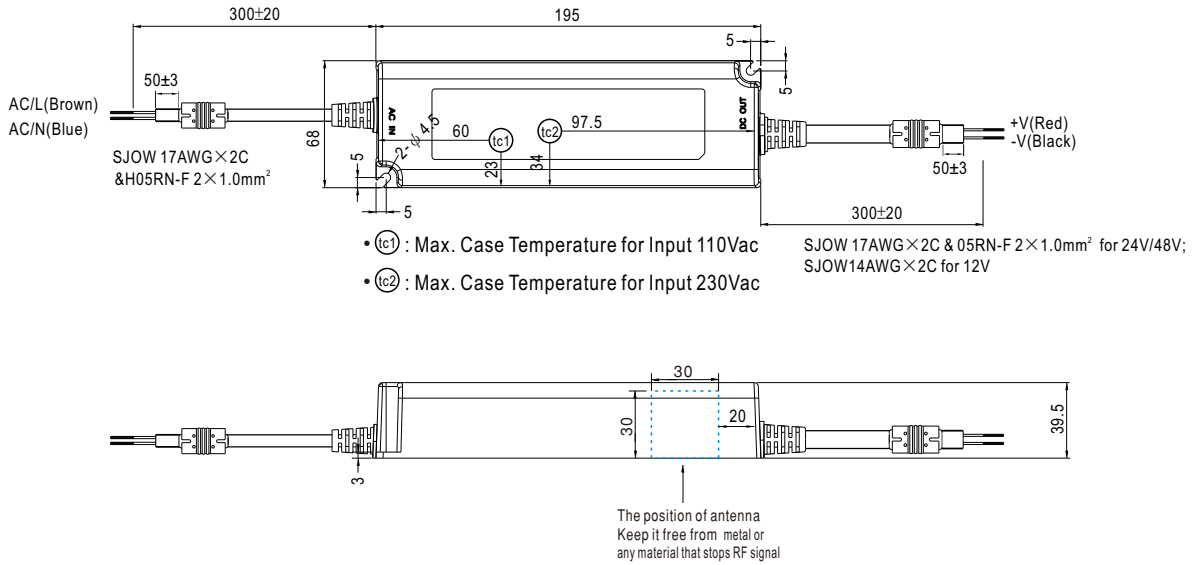

■ **Recommend Mounting Direction**

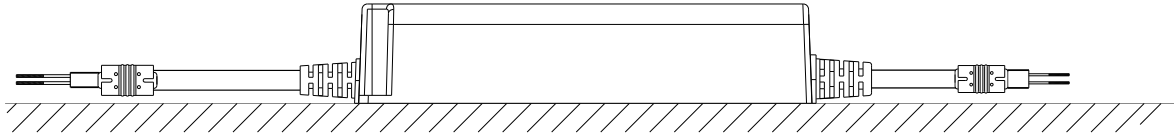

■ **Installation Manual**

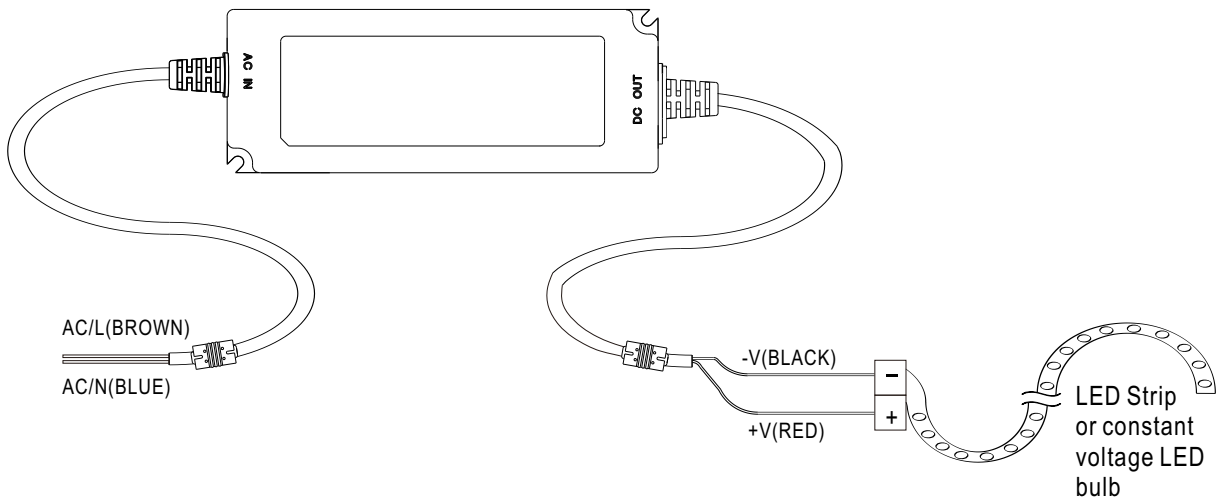

◎ **Cautions**

- Before commencing any installation or maintenance work, please disconnect the power supply from the utility. Ensure that it cannot be re-connected inadvertently!
- Keep proper ventilation around the unit and do not stack any object on it. Also a 10-15 cm clearance must be kept when the adjacent device is a heat source.
- Mounting orientations other than standard orientation or operate under high ambient temperature may increase the internal component temperature and will require a de-rating in output current.
- Current rating of an approved primary /secondary cable should be greater than or equal to that of the unit. Please refer to its specification.
- For LED drivers with waterproof connectors, verify that the linkage between the unit and the lighting fixture is tight so that water cannot intrude into the system.
- Tc max. is identified on the product label. Please make sure that temperature of Tc point will not exceed limit.
- Suitable for indoor use or outdoor use without direct sunlight exposure. Please avoid immerse in the water over 30 minutes.
- The power supply is considered as a component that will be operated in combination with final equipment. Since EMC performance will be affected by the complete installation, the final equipment manufacturers must re-qualify EMC Directive on the complete installation again.