

■ Features

- Compliance with railway standard EN50155
- DIP 2"x1" package with standard pinout
- 18:1(8.5~160Vdc) ultra-wide input range
- Wide operating temperature range -40 ~ +95°C
- No minimum load required
- Full encapsulated
- Protections: Short circuit (Continuous) / Overload / Over voltage / Input under voltage
- 3KVAC I/O isolation
- Operating altitude up to 5000 meters (Note.5)
- Remote ON/OFF control
- 3 years warranty

■ Applications

- Bus, tram, metro or railway system
- Telecom/datacom system
- Wireless network
- Industrial control facility
- Instrument
- Analyzer
- Highly vibrating, heavily dusty, extremely low or high temperature harsh environment

■ GTIN CODE

MW Search: <https://www.meanwell.com/serviceGTIN.aspx>

■ Description

RSDW20UW and RDDW20UW series are 20W module type DC-DC reliable railway converter with 2"x1" package. It features international standard pins, a high efficiency up to 89%, wide working temperature range -40~+95°C, 3KVAC I/P-O/P isolation voltage, meet EN50155 with external circuits, continuous-mode short circuit protection, etc. The models account for 8.5~160VDC 18:1 ultra-wide input range, and various output voltage, 5V/12V/15V for single output and ±12V/±15V/±24V for dual outputs, which are suitable for railway, trams, buses and also can be used in the harsh environment with high vibration, high dust, extremely low or high temperature, etc.

■ Model Encoding

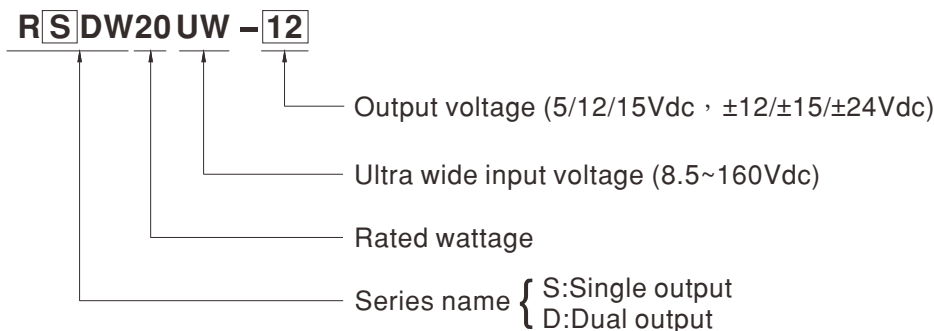



MODEL SELECTION TABLE							
ORDER NO.	INPUT			OUTPUT		EFFICIENCY (Typ.)	CAPACITOR LOAD (MAX.)
	INPUT VOLTAGE (RANGE)	INPUT CURRENT		OUTPUT VOLTAGE	OUTPUT CURRENT		
		NO LOAD	FULL LOAD				
RSDW20UW-05	Normal 12V,24V,48V,72V,96V,110V (8.5 ~ 160V)	5mA	323mA	5V	4000mA	85.5%	6800μF
RSDW20UW-12		10mA	312mA	12V	1670mA	89%	3300μF
RSDW20UW-15		8mA	312mA	15V	1330mA	89%	2200μF
RDDW20UW-12		8mA	312mA	±12V	±0 ~ 833mA	88%	*820μF
RDDW20UW-15		9mA	312mA	±15V	±0 ~ 667mA	89%	*680μF
RDDW20UW-24		9mA	309mA	±24V	±0 ~ 417mA	89%	*330μF

* For each output

SPECIFICATION				
INPUT	VOLTAGE RANGE	8.5 ~ 160Vdc		
	SURGE VOLTAGE (100ms max.)	200Vdc		
	FILTER	Pi type		
	PROTECTION	4A fast acting fuse		
OUTPUT	VOLTAGE ACCURACY	±1.0%		
	RATED POWER	20W		
	RIPPLE & NOISE <small>Note.2</small>	100mVp-p		
	LINE REGULATION <small>Note.3</small>	±0.2%		
	LOAD REGULATION <small>Note.4</small>	Single output models: ±0.3%, Dual output models: ±1%		
	CROSS REGULATION	±5% @ 25%~100% load		
	SWITCHING FREQUENCY (Typ.)	200KHz		
	EXTERNAL TRIM ADJ. RANGE (Typ.)	-20% ~ +15% (Single output model only)		
PROTECTION	SHORT CIRCUIT	Protection type : Continuous, automatic recovery		
	OVERLOAD	110 ~ 180% rated output power Protection type : Recovers automatically after fault condition is removed		
	OVER VOLTAGE	Protection type : Clamp by diode		
	UNDER VOLTAGE LOCKOUT	Start-up voltage	9Vdc	
	Shutdown voltage	8Vdc		
FUNCTION	REMOTE CONTROL	Power ON: >4.0~160Vdc or open circuit Power OFF: <1.2Vdc or short		
ENVIRONMENT	COOLING	Free-air convection		
	WORKING TEMP.	-40 ~ +95°C (Refer to "Derating Curve")		
	CASE TEMPERATURE	+105°C max. (+110°C thermal shutdown)		
	WORKING HUMIDITY	20% ~ 90% RH non-condensing		
	STORAGE TEMP., HUMIDITY	-55 ~ +125°C, 10 ~ 95% RH non-condensing		
	TEMP. COEFFICIENT	0.03% / °C (0 ~ 95°C)		
	SOLDERING TEMPERATURE	1.5mm from case of 1 ~ 3sec./260°C max.		
	VIBRATION	10 ~ 500Hz, 2G 10min./1cycle, period for 60min. each along X, Y, Z axes		
	OPERATING ALTITUDE <small>Note.5</small>	5000 meters		
SAFETY & EMC (Note.6)	SAFETY STANDARDS	UL62368-1, EAC TP TC 004 approved		
	WITHSTAND VOLTAGE	I/P-O/P:3KVAC		
	ISOLATION RESISTANCE	I/P-O/P:100M Ohms / 500VDC / 25°C / 70% RH		
	ISOLATION CAPACITANCE (Typ.)	20pF		
	EMC EMISSION	Parameter	Standard	Test Level / Note
		Conducted	BS EN/EN50121-3-2	Class A/B with external components
	EMC IMMUNITY	Radiated	BS EN/EN50121-3-2	N/A
		Parameter	Standard	Test Level / Note
		ESD	BS EN/EN61000-4-2	Level 3, ±8KV air, ±6KV contact
		Radiated Susceptibility	BS EN/EN61000-4-3	Level 3, 80~1000MHz, 20V/m
		EFT/Bursts	BS EN/EN61000-4-4	Level 3, On power input port, ±2KV external input capacitor required
		Surge	BS EN/EN61000-4-5	Level 4, Line to earth, ±4KV Line to Line, ±2KV
Conducted	BS EN/EN61000-4-6	Level 3, 0.15~80MHz, 10V		
RAILWAY STANDARD	EN50155 including EN61373 for shock & vibration, EN50121-3-2 for EMC			
OTHERS	MTBF	1570Khrs MIL-HDBK-217F(25°C)		
	DIMENSION (L*W*H)	50.8*25.4*10.2mm (2*1*0.4 inch)		
	CASE MATERIAL	Black coated copper with Non-Conductive Base		
	PACKING	35g ; 12pcs/per tube, 300pcs/25 tube/per carton		
NOTE	1.All parameters are specified at normal input(72Vdc), rated load, 25°C 70% RH ambient. 2.Ripple & noise are measured at 20MHz by using a 12" twisted pair terminated with a 0.1µf & 47µf capacitor. 3.Line regulation is measured from low line to high line at rated load. 4.Load regulation is measured from 0% to 100% rated load. 5.The ambient temperature derating of 3.5°C/1000m for operating altitude higher than 2000m(6500ft). 6.The final equipment must be re-confirm that it still meet EMC directives. For guidance on how to perform these EMC tests, please refer to "EMI testing of component power supplies."(as available on http://www.meanwell.com) ※ Product Liability Disclaimer : For detailed information, please refer to https://www.meanwell.com/serviceDisclaimer.aspx			

External Output Trimming

In order to trim the voltage up or down, one needs to connect the trim resistor either between the trim pin and -Vout for trim-up or between trim pin and +Vout for trim-down. The output voltage trim range is -20% to +15%. This is shown in Figures 1 and 2:

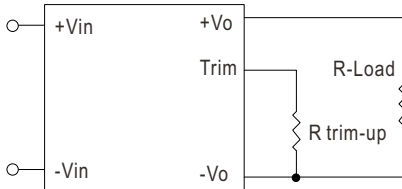

Figure 1. Trim-up Voltage Setup

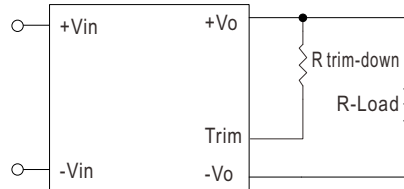

Figure 2. Trim-down Voltage Setup

1. The RSDW20UW-05 value of R_{trim-up} defined as:

$$R_{trim-up} = \frac{22.13 - 3.976 \times (V_o - V_{o, nom})}{7.017 \times (V_o - V_{o, nom})} - 3.3 \text{ (K}\Omega\text{)}$$

2. The RSDW20UW-12 value of R_{trim-up} defined as:

$$R_{trim-up} = \frac{120.76}{3 \times (V_o - V_{o, nom})} - 18 \text{ (K}\Omega\text{)}$$

3. The RSDW20UW-15 value of R_{trim-up} defined as:

$$R_{trim-up} = \frac{104.42}{2.28 \times (V_o - V_{o, nom})} - 18 \text{ (K}\Omega\text{)}$$

Where

R_{trim-up} is the external resistor in Kohm.

V_{o, nom} is the nominal output voltage.

V_o is the desired output voltage.

Trim up Resistor Values are internal to the unit and are defined in Table 1.

For example, to trim-up the output voltage of 5V module (RSDW20UW-05) by 5% to 5.25V, R_{trim-up} is calculated as follows:

$$R_{trim-up} = \frac{22.13 - 3.976 \times (5.25 - 5)}{7.017 \times (5.25 - 5)} - 3.3 = 8.75 \text{ (K}\Omega\text{)}$$

Table 1 – The typical value of R_{trim-up}

R _{trim up} %	5V	12V	15V
	R _{trim up} (KΩ)		
1%	59.21	317.46	287.32
2%	27.67	149.73	134.66
3%	17.16	93.82	83.77
4%	11.90	65.86	58.33
5%	8.75	49.09	43.06
6%	6.65	37.91	32.89
7%	5.14	29.92	25.62
8%	4.02	23.93	20.17
9%	3.14	19.27	15.92
10%	2.44	15.55	12.53
11%	1.87	12.50	9.76
12%	1.39	9.95	7.44
13%	0.99	7.80	5.49
14%	0.64	5.96	3.81
15%	0.34	4.36	2.35

4. The RSDW20UW-05 value of R_{trim-down} defined as:

$$R_{\text{trim-down}} = \frac{42 - 16.803 \times (V_{o, \text{nom}} - V_o)}{7.017 \times (V_{o, \text{nom}} - V_o)} - 3.3 \text{ (K}\Omega\text{)}$$

5. The RSDW20UW-12 value of R_{trim-down} defined as:

$$R_{\text{trim-down}} = \frac{206.116}{3 \times (V_{o, \text{nom}} - V_o)} - 27.08 \text{ (K}\Omega\text{)}$$

6. The RSDW20UW-15 value of R_{trim-down} defined as:

$$R_{\text{trim-down}} = \frac{206.116}{2.28 \times (V_{o, \text{nom}} - V_o)} - 27.08 \text{ (K}\Omega\text{)}$$

Where

R_{trim-down} is the external resistor in Kohm.

V_{o, nom} is the nominal output voltage.

V_o is the desired output voltage.

Trim down Resistor Values are internal to the unit and are defined in Table 2.

For example, to trim-down the output voltage of 12V module (RSDW20UW-12) by 5% to 11.4V, R_{trim-down} is calculated as follows:

$$R_{\text{trim-down}} = \frac{206.116}{3 \times (12 - 11.4)} - 27.08 = 87.43 \text{ (K}\Omega\text{)}$$

Table 2 – The typical value of R_{trim-down}

R _{trim-down} %	5V	12V	15V
	R _{trim-down} (KΩ)		
1%	114.03	545.46	575.60
2%	54.17	259.19	274.26
3%	34.21	163.77	173.81
4%	24.24	116.06	123.59
5%	18.25	87.43	93.46
6%	14.26	68.34	73.37
7%	11.41	54.71	59.02
8%	9.27	44.49	48.25
9%	7.61	36.54	39.88
10%	6.28	30.17	33.19
11%	5.19	24.97	27.71
12%	4.28	20.63	23.14
13%	3.52	16.96	19.28
14%	2.86	13.82	15.97
15%	2.29	11.09	13.10
16%	1.79	8.70	10.59
17%	1.35	6.60	8.37
18%	0.96	4.73	6.40
19%	0.61	3.05	4.64
20%	0.29	1.55	3.05

The RSDW20UW-05 models is adjustable within the range of -20% to +15%.

For RSDW20UW-12 and RSDW20UW-15 models, see input & output trim curves for trim up and trim down ranges.

RSDW20UW-12

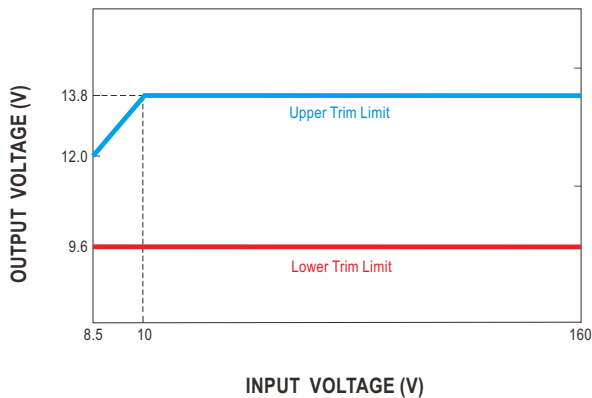

RSDW20UW-15

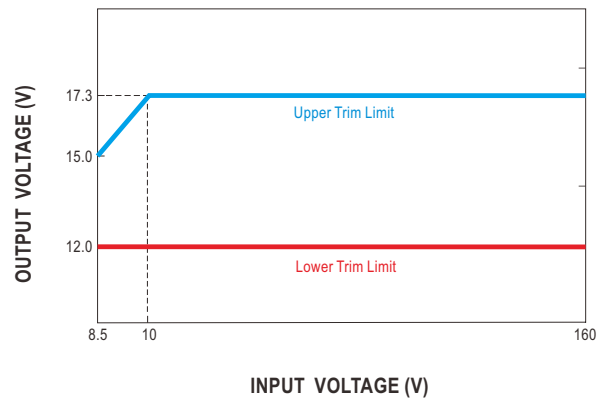

Mechanical Specification

- All dimensions in mm (inch)
- Tolerance: $x.x \pm 0.5\text{mm}$ ($x.xx \pm 0.02"$)
 $x.xx \pm 0.25\text{mm}$ ($x.xxx \pm 0.010"$)
- Pin size is: $0.5 \pm 0.05\text{mm}$ ($0.02" \pm 0.002"$)

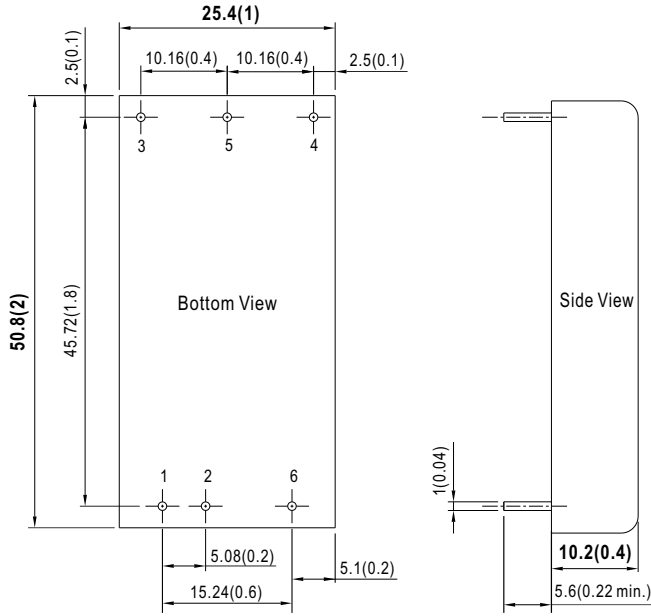

Plug Assignment

Pin-Out		
Pin No.	RSDW20UW (Single output)	RDDW20UW (Dual output)
1	+Vin	+Vin
2	-Vin	-Vin
3	+Vout	+Vout
4	Trim	-Vout
5	-Vout	Common
6	Remote ON/OFF	Remote ON/OFF

Derating Curve

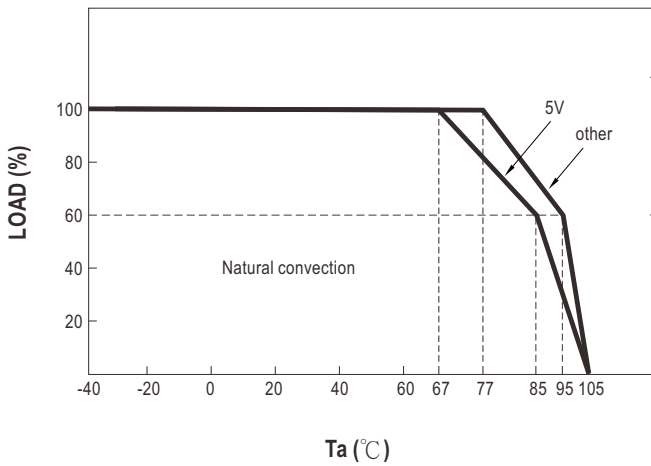

■ Output derating VS Input voltage

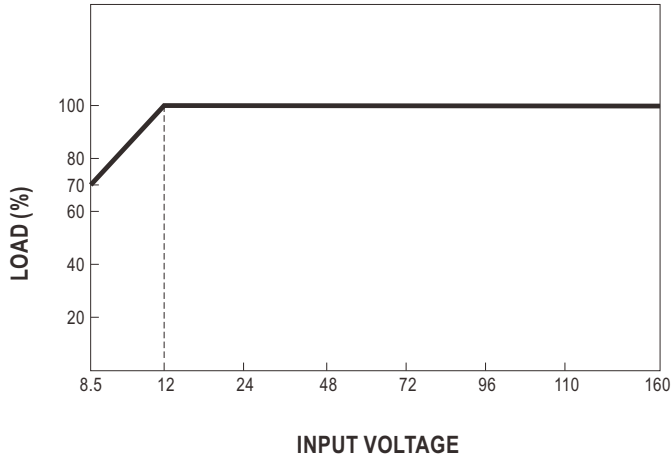

■ EMC Suggestion Circuit

※ EMI Test standard: BS EN/EN55032 Conducted & Radiated Emission, BS EN/EN50121-3-2:2016 Output Conducted Emission
 Test Condition: Input Voltage: 110Vdc, Output Load: Full Load

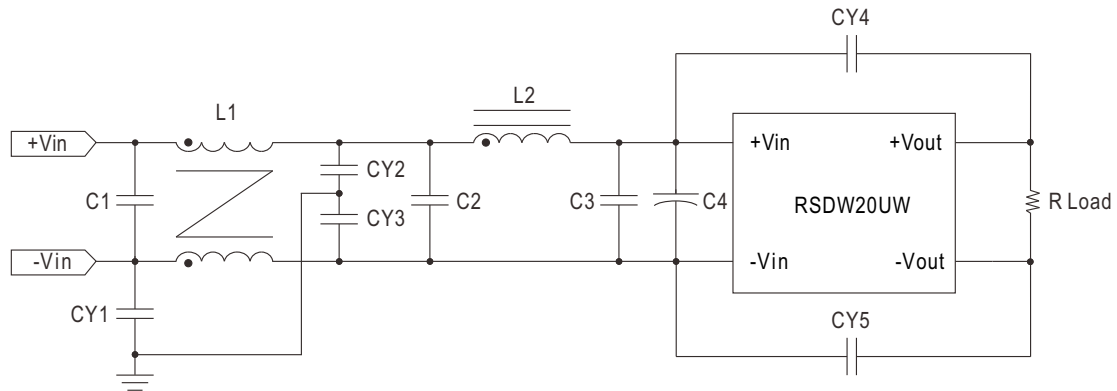

Model No.	BS EN/EN55032 Class B						
	C1,C2,C3	C4	CY1	CY2, CY3	CY4, CY5	L1	L2
RSDW20UW-05	1uF/250V 1812 Ceramic capacitor	120uF/220V KXJ Series Aluminum capacitor	680pF 400VAC Y1 capacitor	500pF 400VAC Y1 capacitor	2200pF 400VAC Y1 capacitor	1.4mH φ0.4mmx1/13T ACME A151 T10x5x5C	10μH/7A 2525CZ Vishay
RSDW20UW-12							
RSDW20UW-15							
RDDW20UW-15			470pF 400VAC Y1 capacitor				
RDDW20UW-15							
RDDW20UW-15							

Note: C1, C2, C3: 1812 X7R ceramic capacitor.
 C4: NIPPON CHEMI-CON KXJ series aluminum capacitor or equivalent.
 CY1, CY2, CY3, CY4, CY5: TDK Y1 capacitor or equivalent.
 L1: 1.4mH φ0.4mmx1/13T ACME A151 T10x5x5C (G91C9925115).
 L2: 10μH/7A 2525CZ VISHAY (G91B0904007).

■ Packing

Standard Tube Packing	MPQ Per Tube (PCS)	One Tube G.W.	Max. Q'TY/ Carton(PCS)	One Carton G.W.
<p>Unit : mm</p> <p>CARTON L390.9 x W284.8 x H175.7</p>	12	498g	300	14.5Kg

■ Installation Manual

Please refer to : <http://www.meanwell.com/manual.html>