



- Features :
 - 2:1 wide input range
 - 4:1 wide input range(option)
 - 1500VDC I/O isolation
 - 3000VDC I/O isolation(option)
 - Built-in EMI filter
 - Protections: Short circuit / Overload
 - Cooling by free air convection
 - Six-sided shield metal case
 - 100% burn-in test
 - Low cost / High reliability
 - Approvals: FCC / EAC / CE / UKCA
 - 2 years warranty

■ GTIN CODE

MW Search: <https://www.meanwell.com/serviceGTIN.aspx>



SPECIFICATION

ORDER NO.	SKA15A-033	SKA15B-033	SKA15C-033	SKA15A-05	SKA15B-05	SKA15C-05	SKA15A-12	SKA15B-12	SKA15C-12	SKA15A-15	SKA15B-15	SKA15C-15													
OUTPUT	DC VOLTAGE			5V			12V			15V															
	CURRENT RANGE			300 ~ 3000mA			125 ~ 1250mA			100 ~ 1000mA															
	RATED POWER			15W																					
	RIPPLE & NOISE (max.) Note.2			50mVp-p			60mVp-p			60mVp-p															
	LINE REGULATION Note.3			±0.2%																					
	LOAD REGULATION Note.4			±0.5%																					
	VOLTAGE ACCURACY			±2.0%																					
	SWITCHING FREQUENCY			150KHz min.																					
EXTERNAL CAPACITANCE LOAD (max.)			2700uF	2700uF	1000uF	2700uF	2700uF	1000uF	1800uF	1800uF	680uF	1500uF	1500uF	560uF											
INPUT	VOLTAGE RANGE												A: 9 ~ 18VDC B: 18 ~ 36VDC C: 36 ~ 72VDC												
	EFFICIENCY (Typ.)												76%	76%	76%	78%	78%	80%	82%	80%	82%	82%	82%	80%	82%
	DC CURRENT												Full load A: 1700mA B: 800mA C: 400mA No load A: 20mA B: 30mA C: 15mA												
	FILTER												Pi network												
	PROTECTION												Fuse recommended												
PROTECTION (Note. 5)	OVER CURRENT												110% ~ 250% rated output power Protection type : Hiccup mode, recovers automatically after fault condition is removed												
	SHORT CIRCUIT												All output equipped with short circuit Protection type : Hiccup mode, recovers automatically after fault condition is removed												
ENVIRONMENT	WORKING TEMP.												-40 ~ +71°C (Refer to "Derating Curve")												
	WORKING HUMIDITY												20% ~ 90% RH non-condensing												
	STORAGE TEMP., HUMIDITY												-40 ~ +105°C, 10 ~ 95% RH												
	TEMP. COEFFICIENT												±0.03% / °C (0 ~ 50°C)												
	VIBRATION												10 ~ 500Hz, 2G 10min./1cycle, period for 60min. each along X, Y, Z axes												
SAFETY & EMC	SAFETY STANDARDS												EAC TP TC 020/2011approved												
	WITHSTAND VOLTAGE												I/P-O/P:1.5KVDC												
	ISOLATION RESISTANCE												I/P-O/P: 100M Ohms / 500VDC / 25°C / 70% RH												
	EMC EMISSION												Compliance to BS EN/EN55032 Class A, FCC part 15 Class A, EAC TP TC 020												
	EMC IMMUNITY												Compliance to BS EN/EN61000-4-2,3,4,5,6,8, light industry level, criteria A, EAC TP TC 020												
OTHERS	MTBF												300Khrs min. MIL-HDBK-217F(25°C)												
	DIMENSION												50.8*25.4*11.27 mm or 2**1**0.44" inch (L*W*H)												
	PACKING												31.2g ; 10pcs/per tube, 400pcs/40 tube/per carton												

■ Mechanical Specification

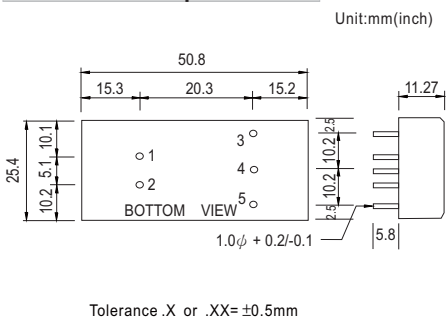

■ Pin Configuration

Pin No.	Output
1	+Vin
2	-Vin
3	+Vout
4	No Pin
5	-Vout

■ Derating Curve

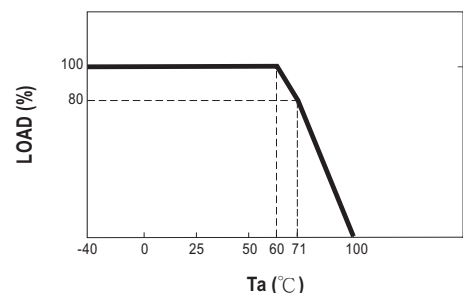

NOTE

- All parameters are specified at normal input, rated load, 25°C 70% RH ambient.
 - Ripple & noise are measured at 20MHz by using a 12" twisted pair terminated with a 0.1uf & 47uf capacitor.
 - Line regulation is measured from low line to high line at rated load.
 - Load regulation is measured from 10% to 100% rated load.
 - Please prevent the converter from operating in overload or short circuit condition for more than 30 seconds.
- ※ Product Liability Disclaimer : For detailed information, please refer to <https://www.meanwell.com/serviceDisclaimer.aspx>

■ Packing

Standard Tube Packing	MPQ Per Tube (PCS)	One Tube G.W.	Max. Q'TY/ Carton(PCS)	One Carton G.W.
<p>Unit : mm</p> <p>Tube pattern</p> <p>CARTON L620 x W230 x H230</p>	10	400g	400	16.8Kg

■ Installation Manual

Please refer to : <http://www.meanwell.com/manual.html>